

# LOGAN

Scheme electrica

# Siguranțe și Relee

## CUTIE SIGURANȚE ȘI RELEE HABITACLU (1016)



### situație

Această cutie este situată în habitacul, pe partea stângă a planșei de bord.

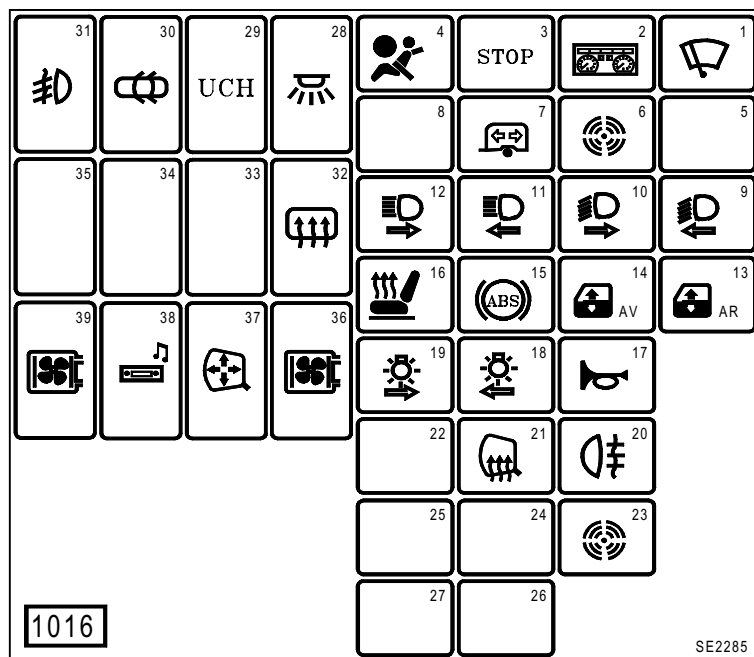











### Etichete siguranțe :



Alocare siguranțe și relee (în funcție de nivelul de echipare)









Nr.	Simbol	Amper	Legătură	Denumire
F1		20A	AP7	<b>Siguranță</b> motor ștergător parbriz(212) - ansamblu spălător-ștergător geam(145) - Unitate Centrală Habitaclu (645)
F2		5A	AP29	<b>Siguranță</b> tablou de bord (247) - relee injecție(1047) - unitate centrală injecție (120)
F3	STOP	20A	AP1	<b>Siguranță</b> contactor stop (160) - ansamblu spălător-ștergător geam (145) - pompă spălător far (219) - contactor lămpi mers înapoi (155)
F4		10A	AP10	<b>Siguranță</b> unitate centrală airbag pretensionatoare (756) - Unitate Centrală Habitaclu (645) - priză de diagnosticare (225) - unitate transponder (957) - suport relee lumini de zi (1034)
F5		--	--	Neutilizat

## Siguranțe și Relee

F6		--	--	Neutilizat
F7		--	--	Neutilizat
F8		--	--	Neutilizat
F9		10A	CPG	<b>Siguranță</b> proiector stânga (227) - tablou de bord (247) - pompă spălător far (219)
F10		10A	CPD	<b>Siguranță</b> proiector dreapta (226)
F11		10A	RPG	<b>Siguranță</b> proiector stânga (227) - tablou de bord (247)
F12		10A	RPD	<b>Siguranță</b> proiector dreapta (226)
F13		30A	AP30	<b>Siguranță</b> comandă macara electrică geam spate dreapta (130) - comandă macara electrică geam spate stânga (131)
F14		30A	AP39	<b>Siguranță</b> comandă macara geam cu impulsuri șofer (734) - comandă macara electrică geam pasager (133) - comandă macara electrică geam șofer (132)
F15		10A	AP5	<b>Siguranță</b> unitate centrală electrică sistem antiblocare roți (118)
F16		15A	AP22	<b>Siguranță</b> comandă scaun cu încălzire șofer (615) - comandă scaun cu încălzire pasager (616)
F17		15A	67CP	<b>Siguranță</b> avertizor electromagnetic principal (105) - avertizor sonor electromagnetic (967)
F18		10A	LPG	<b>Siguranță</b> lumină de poziție față (185) - lampă spate stânga (173) - lampă iluminare număr de înmatriculare centrală (1324) - tablou de bord (247) - Unitate Centrală Habitaclu (645) - comandă lumini de avarie (125) - tablou de comandă climatizare (319) - radio auto (261) - comandă de blocare electrică uș (123) - brichetă primul rând (101) - comandă lunetă spate cu dezghețare (128) - comandă macara electrică geam șofer (132) - comandă macara electrică geam spate stânga (131) - comandă macara geam cu impulsuri șofer (734)
F19		7.5A	LPD	<b>Siguranță</b> lumină de poziție dreapta (184) - lampă spate dreapta (172) - lampă de iluminare cutie de acte pasager (168)
F20		7.5A	9P	<b>Siguranță</b> proiector de ceață spate (lampă spate stânga 173) - tablou de bord (247)
F21		5A	15RP	<b>Siguranță</b> dezghețare retrovizoare șofer și pasager (239-240)
F22		--	--	Neutilizat
F23		--	--	Neutilizat
F24		--	--	Neutilizat
F25		--	--	Neutilizat
F26		--	--	Neutilizat

## Siguranțe și Relee

---

F27		--	--	Neutilizat
F28		15A	BC	<b>Siguranță</b> întrerupere consumatori: - tablou de bord (247) - radio auto (261) - Unitate Centrală Habitaclu (645)
F29	UCH	15A	BP56	<b>Siguranță</b> Unitate Centrală Habitaclu (645) - priză de diagnosticare (225)
F30		20A	BP3	<b>Siguranță</b> Unitate Centrală Habitaclu (645)
F31		15A	BP16	<b>Siguranță</b> alimentare platină accesoriu releu (299)
F32		20A	AP12	<b>Siguranță</b> comandă lunetă spate cu dezghețare (128)
F33		--	--	Neutilizat
F34		--	--	Neutilizat
F35		--	--	Neutilizat
F36		30A	BP1	<b>Siguranță</b> alimentare dispozitiv de suflare aer rece (233)
F37		5A	BP20	<b>Siguranță</b> comandă retrovizor electric (134)
F38		10A	SP2	<b>Siguranță</b> radio auto (261) - brichetă prima poziție (101) - suport releu lumini de zi (1034)
F39		30A	SP3	<b>Siguranță</b> tablou de comandă climatizare (319) - releu dispozitiv de suflare aer rece (233) - releu comandă (784)

# Siguranțe și Relee

## UNITATE CENTRALĂ HABITACLU (645)

### situație

Această cutie este situată în partea inferioară stânga a planșei de bord.

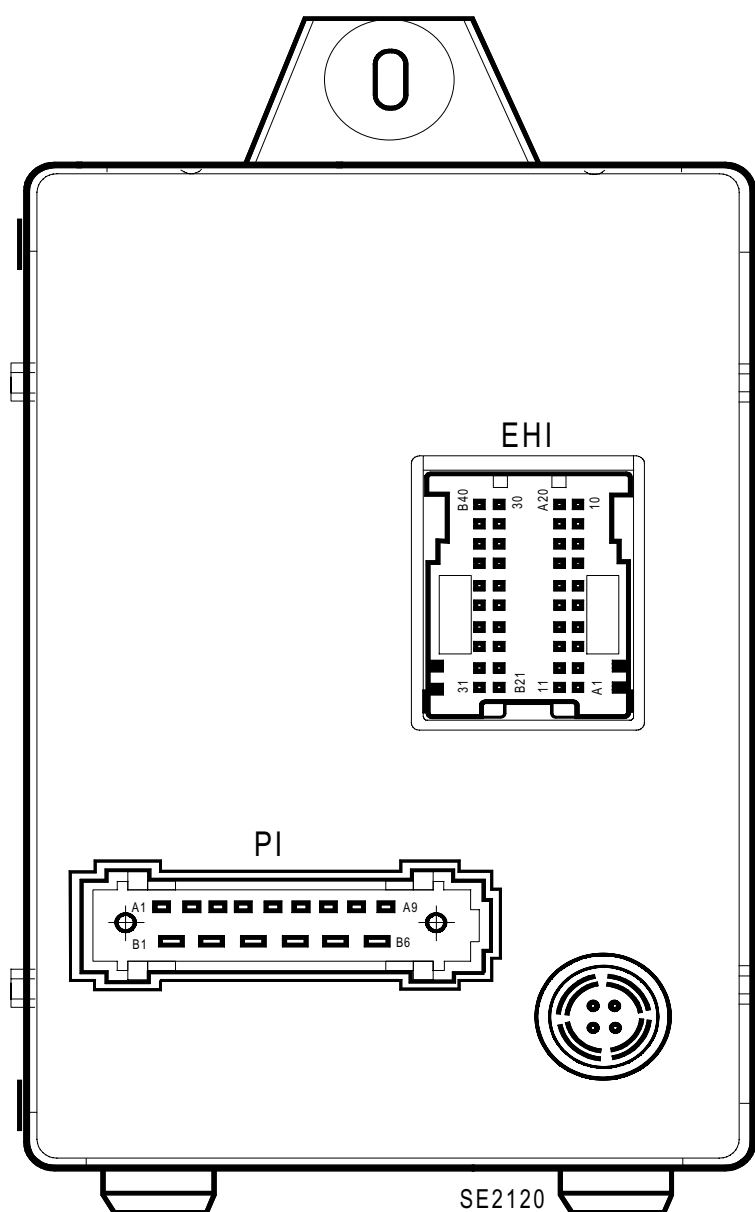

# Siguranțe și Relee

## Alocare (în funcție de nivelul de echipare)

EH1 (Conector cu 40 pini) **NEGRU**

<b>MARO</b>		
<b>Pin</b>	<b>Legătură</b>	<b>Denumire</b>
<b>A1</b>	--	Neutilizată
<b>A2</b>	--	Neutilizată
<b>A3</b>	--	Neutilizată
<b>A4</b>	--	Neutilizată
<b>A5</b>	64E	Comandă + indicator luminos lumină semnalizare direcție
<b>A6</b>	47F	Semnal viteză vehicul
<b>A7</b>	--	Neutilizată
<b>A8</b>	20B	Comandă + temporizator deschidere blocare electrică uș
<b>A9</b>	--	Neutilizată
<b>A10</b>	--	Neutilizată
<b>A11</b>	--	Neutilizată
<b>A12</b>	--	Neutilizată
<b>A13</b>	--	Neutilizată
<b>A14</b>	--	Neutilizată
<b>A15</b>	LPG	+ Lampă de poziție stânga protejată
<b>A16</b>	80X	Semnal microbuz antenă transponder
<b>A17</b>	20A	Comandă + temporizator închidere blocare electrică uș
<b>A18</b>	--	Neutilizată
<b>A19</b>	--	Neutilizată
<b>A20</b>	87H	Semnal - contactor 1 poziție șofer
<b>VERDE</b>		
<b>B21</b>	--	Neutilizată
<b>B22</b>	AP10	+ După contact protejat siguranță lampă stop
<b>B23</b>	60BR	Semnal șoc unitate centrală electrică airbag
<b>B24</b>	14E	Comandă + temporizator ștergător parbriz
<b>B25</b>	--	Neutilizată
<b>B26</b>	64T	Comandă pornire temporizator semnalizator stânga
<b>B27</b>	--	Neutilizată
<b>B28</b>	64S	Comandă pornire temporizator semnalizator dreapta
<b>B29</b>	--	Neutilizată
<b>B30</b>	13N	Comandă - iluminare interioară > Cadru ușă spate
<b>B31</b>	15M	Comandă - releu lunetă spate cu dezghețare
<b>B32</b>	80T	Comandă - martor luminos antidemaraj
<b>B33</b>	64Q	Comandă - temporizator centrală clipitoare
<b>B34</b>	HK	Semnal diagnosticare K
<b>B35</b>	--	Neutilizată
<b>B36</b>	H17	Semnal cod injecție benzină > Diesel > Antidemaraj
<b>B37</b>	--	Neutilizată
<b>B38</b>	H7	Intrare turație motor
<b>B39</b>	15B	Comandă + lunetă spate cu dezghețare
<b>B40</b>	13A	Comandă - iluminare interioară > Cadru ușă față

# Siguranțe și Relee

## Alocare (în funcție de nivelul de echipare)

P1 (Conector cu 15 pini) **ALB**

<b>CRISTALIN</b>		
<b>Pin</b>	<b>Legătură</b>	<b>Denumire</b>
<b>A1</b>	NC	Masă electronică stâlp față stânga
<b>A2</b>	13E	Comandă - iluminare plafonieră > Temporizator
<b>A3</b>	BP56	+ Baterie protejat siguranță > Calculator electronic
<b>A4</b>	14D	Comandă viteză mică temporizator ștergător parbriz
<b>A5</b>	AP7	+ După contact protejat siguranță ștergător parbriz
<b>A6</b>	14C	Comandă + oprire corespunzătoare ștergător parbriz
<b>A7</b>	--	Neutilizată
<b>A8</b>	64D	Comandă lumini semnalizare direcție dreapta
<b>A9</b>	64C	Comandă lumini semnalizare direcție stânga
<b>NEGRU</b>		
<b>Pin</b>	<b>Legătură</b>	<b>Denumire</b>
<b>B1</b>	--	Neutilizată
<b>B2</b>	20D	Comandă + închidere blocare electrică uș
<b>B3</b>	BP3	+ Baterie protejat blocare electrică uș
<b>B4</b>	20C	Comandă + deschidere blocare electrică uș
<b>B5</b>	BPT	+ Baterie protejat temporizator
<b>B6</b>	BC	+ Baterie prin releu sau întrerupere circuit

-

# Siguranțe și Relee

## PLATINE SIGURANȚE ȘI RELEE (299 - 597 - 784 - 1034 - 1047 - 233 - 336)

### situație

Aceste cutii sunt plasate în cutia de interconectări motor, în jurul locașului bateriei.

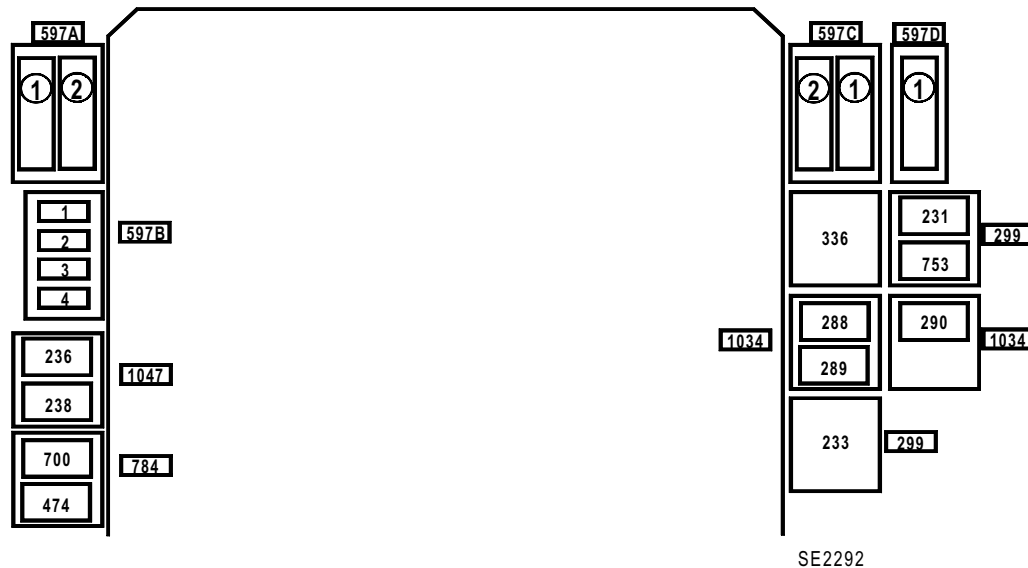

### Motoare K4M, K7J, K7M

Alocare siguranțe (în funcție de nivelul de echipare)

#### Platină 597A

Nr.	Amper	Legătură	Denumire
F1	60A	BP13	Siguranță antifurt (104) - monomanetă (209) - releu lumini de zi (1034)
F2	60A	BP11	Siguranță monomanetă (209) - cutie siguranță habitaclu (1016)

#### Platină 597B

Nr.	Amper	Legătură	Denumire
F1	30A	BP7	Siguranță alimentare platină releu (784)
F2	25A	BP17	Siguranță alimentare releu injecție (1047)
F3	5A	BP37	Siguranță alimentare releu injecție (1047) - calculator injecție (120)

#### Platină 597C

Nr.	Amper	Legătură	Denumire
F1	50A	BP14	Siguranță calculator sistem antiblocare roți (118)
F2	25A	BP88	Siguranță calculator sistem antiblocare roți (118)

#### Platină 597D

Nr.	Amper	Legătură	Denumire
F1	40A	BP7	Siguranță alimentare releu viteză mare grup motoventilator (336) - platină releu (784)



# Siguranțe și Relee

---

Alocare relee (în funcție de nivelul de echipare)

## Platină 299

Nr.	Denumire
231	Releu lampă de ceață față
753	Releu pompă spălător de faruri

## Platină 784

Nr.	Denumire
474	Releu ambreiaj aer condiționat
700	Releu viteză mică grup motoventilator

## Platine 1034

Nr.	Denumire
288	Releu lumini de zi
289	Releu lumini de zi
290	Releu lumini de zi

## Platină 1047

Nr.	Denumire
236	Releu pompă de carburant
238	Releu blocare injecție

Relee unitare

Nr.	Denumire
233	Releu dispozitiv de suflare aer rece
336	Releu viteză mare grup motoventilator

# REPERTOAR CRITERII

TITLURI SCURTE	TITLURI LUNGI
ABCO01	AIRBAG ȘOFER
ABPA01	AIRBAG PASAGER
ABS	SISTEM ANTIBLOCARE ROȚI
ADAC	ASISTENȚĂ LA CONDUCERE
CA	AER CONDIȚIONAT
CHAUFO	ÎNCĂLZIRE OBȘNUITĂ
DA	DIRECȚIE ASISTATĂ
DM	DIRECȚIE MANUALĂ
E0	NIVEL DE ECHIPARE E0
E02B	NORMĂ DE DEPOLUARE EURO 02 FĂRĂ OBD
E03A	NORMĂ DE DEPOLUARE EURO 03 CU OBD
E1	NIVEL DE ECHIPARE E1
E2	NIVEL DE ECHIPARE E2
ESS	BENZINĂ
GDFROI	CLIMATIZARE TEMPERATURĂ FOARTE SCĂZUTĂ
K7J	MOTOR K7J
K7J710	MOTOR K7J INDICE 710
K7M	MOTOR K7M
K7M710	MOTOR K7M INDICE 710
L90	FAMILIE L 90
LAVPH	SPĂLĂTOR DE FARURI
LVAREL	MACARA GEAM SPATE ELECTRICĂ
LVARMA	MACARA GEAM SPATE MANUALĂ
LVAVEL	MACARA GEAM ELECTRICĂ
LVAVMA	MACARA GEAM FAȚĂ MANUALĂ
LVCPIE	MACARA CU IMPULSURI GEAM ȘOFER ȘI ELECTRICĂ PASAGER
PROJAB	PROIECTOARE DE CEAȚĂ
RETROE	2 RETROVIZOARE EXTERIOARE REGLAJ ELECTRIC
RETROR	2 RETROVIZOARE EXTERIOARE CU REGLAJ MANUAL
SADAC	FĂRĂ ASISTENȚĂ LA CONDUCERE
SGACHA	SCAUN CU ÎNCĂLZIRE
SOP01	SISTEM DESCHIDERE/ÎNCHIDERE UȘI CU CARTELĂ MAGNETICĂ
SOP02	SISTEM DESCHIDERE/ÎNCHIDERE UȘI MĂINI LIBERE
SOP03	SISTEM DESCHIDERE ÎNCHIDERE UȘĂ TIP 03
SRADIO	VEHICUL FĂRĂ RADIO AUTO
SSABCO	FĂRĂ AIRBAG ȘOFER
SSABPA	FĂRĂ AIRBAG PASAGER
SSABS	FĂRĂ SISTEM ANTIBLOCARE ROȚI
TEMP	CLIMATIZARE POTRIVITĂ

# REPERTOAR LEGĂTURI

CODURI LEGĂTURI	TITLURI LEGĂTURI
137C	COMANDĂ MARTOR LUMINOS DEFECT DEPOLUARE
13A	COMANDĂ- ILUMINARE INTERIOR > CADRU UȘĂ
13E	COMANDĂ- ILUMINARE PLAFONIERĂ > TEMPORIZATOR
13N	COMANDĂ- ILUMINARE INTERIOARĂ > CADRU UȘĂ SPATE
14A	COMANDĂ+ VITEZĂ MICĂ ȘTERGĂTOR PARBRIZ
14B	COMANDĂ+ VITEZĂ MARE ȘTERGĂTOR PARBRIZ
14C	COMANDĂ+ OPRIRE CORESPUNZĂTOARE ȘTERGĂTOR PARBRIZ
14D	COMANDĂ VITEZĂ MICĂ TEMPORIZATOR ȘTERGĂTOR PARBRIZ
14E	COMANDĂ+ TEMPORIZATOR ȘTERGĂTOR PARBRIZ
15A	COMANDĂ MARTOR LUMINOS LUNETĂ SPATE CU DEZGHEȚARE
15B	COMANDĂ+ LUNETĂ SPATE CU DEZGHEȚARE
15LP	COMANDĂ+ DEZGHEȚARE LUNETĂ SPATE PROTEJAT
15M	COMANDĂ- RELEU LUNETĂ CU DEZGHEȚARE
15RP	COMANDĂ+ DEZGHEȚARE RETROVIZOR PROTEJAT
16A	COMANDĂ+ POMPĂ SPĂLĂTOR DE PARBRIZ
17A	COMANDĂ- ILUMINARE COMPARTIMENT DE DEPOZITARE
20A	COMANDĂ+ TEMPORIZATOR ÎNCHIDERE BLOCARE ELECTRICĂ UȘI
20B	COMANDĂ+ TEMPORIZATOR DESCHIDERE BLOCARE ELECTRICĂ UȘI
20C	COMANDĂ+ DESCHIDERE BLOCARE ELECTRICĂ UȘI
20D	COMANDĂ+ ÎNCHIDERE BLOCARE ELECTRICĂ UȘI
21A	COMANDĂ URCARE MACARA GEAM ȘOFER
21B	COMANDĂ COBORÂRE MACARA GEAM ȘOFER
22A	COMANDĂ URCARE MACARA GEAM PASAGER
22B	COMANDĂ COBORÂRE MACARA GEAM PASAGER
23E	COMANDĂ BOBINĂ RELEU BLOCARE FUNCȚIE SPATE
23G	COMANDĂ ÎNTRERUPĂTOR CU DOUĂ POZIȚII 1 MACARA GEAM SPATE DREAPTA
23H	COMANDĂ ÎNTRERUPĂTOR CU DOUĂ POZIȚII 2 MACARA GEAM SPATE DREAPTA
23J	COMANDĂ ÎNTRERUPĂTOR CU DOUĂ POZIȚII 1 MACARA GEAM SPATE STÂNGA
23K	COMANDĂ ÎNTRERUPĂTOR CU DOUĂ POZIȚII 2 MACARA GEAM SPATE STÂNGA
28A	COMANDĂ- MARTOR LUMINOS PRESIUNE ULEI
2A	COMANDĂ- MARTOR LUMINOS ÎNCĂRCARE ALTERNATOR
31A	COMANDĂ- MARTOR LUMINOS TEMPERATURĂ APĂ
34A	SEMNAL+ DIFUZOR SPATE STÂNGA
34B	SEMNAL- DIFUZOR SPATE STÂNGA
34C	SEMNAL- DIFUZOR SPATE DREAPTA
34D	SEMNAL+ DIFUZOR SPATE DREAPTA
34E	SEMNAL+ DIFUZOR FAȚĂ DREAPTA
34F	SEMNAL- DIFUZOR FAȚĂ DREAPTA
34G	SEMNAL+ DIFUZOR FAȚĂ STÂNGA
34H	SEMNAL- DIFUZOR FAȚĂ STÂNGA
38AH	COMANDĂ + MOTOR GRUP MOTOVENTILATOR VITEZA 1
38AJ	COMANDĂ + MOTOR GRUP MOTOVENTILATOR VITEZA 2
38AK	COMANDĂ + MOTOR GRUP MOTOVENTILATOR VITEZA 3
38AL	COMANDĂ + MOTOR GRUP MOTOVENTILATOR VITEZA 4
38DB	COMANDĂ+ VENTILATOR ÎNCĂLZIRE> TABLOU CLIMATIZARE
38K	COMANDĂ ÎNTRERUPERE AER CONDIȚIONAT> CALCULATOR ELECTRONIC BENZINĂ-DIESEL
38R	COMANDĂ+ AMBREIERE AER CONDIȚIONAT
38U	CURSOR REOSTAT
38X	SEMNAL SENZOR PRESIUNE GAZ DE RĂCIRE
38Y	+SENZOR PRESIUNE GAZ DE RĂCIRE
38Z	COMANDĂ CICLU AER CONDIȚIONAT> CALCULATOR ELECTRONIC BENZINĂ-DIESEL
39A	COMANDĂ+ POMPĂ SPĂLĂTOR FARURI
3AA	COMANDĂ- BOBINĂ RELEU BLOCARE INECȚIE

# REPERTOAR LEGĂTURI

CODURI LEGĂTURI	TITLURI LEGĂTURI
3AC	COMANDĂ- BOBINĂ RELEU POMPĂ BENZINĂ
3AJ	SEMNAL+ POTENȚIOMETRU POZIȚIE CLAPETĂ FLUTURE
3AW	SEMNAL+ PRESOSTAT DIRECȚIE ASISTATĂ > CALCULATOR ELECTRONIC INECȚIE
3B	SEMNAL+ SONDĂ TEMPERATURĂ AER
3BB	COMANDĂ ELECTROVANĂ PURJARE CANISTRĂ
3BG	SEMNAL VITEZĂ MOTOR > SENZOR PUNCT MORT SUPERIOR
3BL	SEMNAL- VITEZĂ MOTOR > SENZOR PUNCT MORT SUPERIOR
3BU	COMANDĂ 1 REGLARE RALANTI
3BV	COMANDĂ 2 REGLARE RALANTI
3BW	COMANDĂ 3 REGLARE RALANTI
3BX	COMANDĂ 4 REGLARE RALANTI
3C	SEMNAL+ SENZOR TEMPERATURĂ APĂ
3CR	COMANDĂ- INJECTOR 1
3CS	COMANDĂ- INJECTOR 2
3CT	COMANDĂ- INJECTOR 3
3CU	COMANDĂ- INJECTOR 4
3CV	COMANDĂ- BOBINĂ APRINDERE INJECTOR 1-4
3CW	COMANDĂ- BOBINĂ APRINDERE INJECTOR 2-3
3DQ	- SENZOR DETONAȚIE
3F	SEMNAL SENZOR PRESIUNE ATMOSFERICĂ
3GF	COMANDĂ- REÎNCĂLZIRE SONDĂ DE OXIGEN AMONTE
3GG	COMANDĂ- REÎNCĂLZIRE SONDĂ DE OXIGEN AVAL
3GH	MASĂ SONDĂ DE OXIGEN AMONTE
3GJ	MASĂ SONDĂ DE OXIGEN AVAL
3GK	SEMNAL SONDĂ DE OXIGEN AMONTE
3GL	SEMNAL SONDĂ DE OXIGEN AVAL
3GN	MASĂ SENZOR PRESIUNE COLECTOR
3GR	+ POTENȚIOMETRU CLAPETĂ FLUTURE > SENZOR PRESIUNE REZERVOR
3JK	- TEMPERATURĂ APĂ
3JL	- POTENȚIOMETRU CLAPETĂ FLUTURE
3JN	COMANDĂ- RELEU GRUP MOTOVENTILATOR 1
3JP	COMANDĂ- RELEU GRUP MOTOVENTILATOR 2
3JQ	- TEMPERATURĂ AER
3LG	+SENZOR PRESIUNE ATMOSFERICĂ
3NA	+BOBINĂ MODUL APRINDERE CONTACT INERȚIAL > RELEU POMPĂ DE BENZINĂ
3NR	+ INJECTOARE
3S	SEMNAL+ SENZOR DETONAȚIE 1> FAȚĂ
40A	COMANDĂ DREAPTA>STÂNGA RETROVIZOR ȘOFER
40B	COMANDĂ SUS>JOS RETROVIZOR PASAGER
40C	COMANDĂ SUS>JOS RETROVIZOR ȘOFER
40D	COMANDĂ DREAPTA>STÂNGA RETROVIZOR PASAGER
40E	COMUN MOTOR RETROVIZOR
41A	SEMNAL+ JOJĂ NIVEL DE CARBURANT
42A	SEMNAL+ TEMPERATURĂ APĂ
47A	- JOJĂ NIVEL DE CARBURANT
47F	SEMNAL VITEZĂ VEHICUL
47H	SEMNAL DEBIT DE CARBURANT
47K	COMANDĂ- DERULARE ASISTENȚĂ LA CONDUCERE
49B	COMANDĂ+ GRUP MOTOVENTILATOR
49C	COMANDĂ+ RELEU GRUP MOTOVENTILATOR
4C	SEMNAL SENZOR ROATĂ FAȚĂ STÂNGA
4E	+SENZOR ROATĂ FAȚĂ STÂNGA
4G	SEMNAL SENZOR ROATĂ SPATE STÂNGA

# REPERTOAR LEGĂTURI

CODURI LEGĂTURI	TITLURI LEGĂTURI
4H	+SENZOR ROATĂ SPATE STÂNGA
4M	SEMNAL SENZOR ROATĂ FAȚĂ DREAPTA
4N	+SENZOR ROATĂ FAȚĂ DREAPTA
4S	SEMNAL SENZOR ROATĂ SPATE DREAPTA
4T	+SENZOR ROATĂ SPATE DREAPTA
4Y	- MARTOR LUMINOS DEFECT FRÂNĂ
4Z	- MARTOR LUMINOS SISTEM ANTIBLOCARE ROȚI
60A	-INDICATOR LUMINOS DEFECT EUROBAG
60BR	SEMNAL ȘOC UNITATE CENTRALĂ ELECTRICĂ AIRBAG
60CD	COMANDĂ MARTOR LUMINOS INHIBARE AIRBAG
60DS	SEMNAL CHEIE INHIBARE AIRBAG PASAGER
60DT	- CHEIE INHIBARE AIRBAG PASAGER
60F	+SEMNAL EUROBAG ȘOFER
60G	-SEMNAL EUROBAG ȘOFER
60V	+SEMNAL EUROBAG PASAGER
60W	-SEMNAL EUROBAG PASAGER
64C	COMANDĂ LUMINI SEMNALIZARE DIRECȚIE STÂNGA
64D	COMANDĂ LUMINI SEMNALIZARE DIRECȚIE DREAPTA
64E	COMANDĂ+ INDICATOR LUMINOS LUMINI SEMNALIZARE DIRECȚIE
64Q	COMANDĂ- TEMPORIZATOR CENTRALĂ CLIPITOARE
64S	COMANDĂ PORNIRE TEMPORIZATOR SEMNALIZATOR DREAPTA>CALCULATOR ELECTRONIC
64T	COMANDĂ PORNIRE TEMPORIZATOR SEMNALIZATOR STÂNGA > CALCULATOR ELECTRONIC
65A	COMANDĂ+ LUMINI STOP
67C	COMANDĂ+ SIGURANȚĂ AVERTIZOR SONOR
67CP	COMANDĂ+ AVERTIZOR SONOR > SIGURANȚĂ
80T	COMANDĂ- INDICATOR LUMINOS ANTIDEMARAJ
80X	SEMNAL BUS (INTERFAȚĂ) ANTENĂ TRANSPONDER
87H	SEMNAL- CONTACTOR 1 POZIȚIE ȘOFER
8A	+ RELEU LUMINI DE CEAȚĂ
8B	+ PROIECTOARE DE CEAȚĂ FAȚĂ > RELEU
9J	COMANDĂ+ SIGURANȚĂ LUMINI DE CEAȚĂ SPATE
9P	COMANDĂ+ LUMINI DE CEAȚĂ SPATE PROTEJAT
A	+ DUPĂ CONTACT
AP1	+ DUPĂ CONTACT PROTEJAT SIGURANȚĂ MACARA GEAM FAȚĂ STÂNGA > SPATE STÂNGA
AP10	+ DUPĂ CONTACT PROTEJAT SIGURANȚĂ LUMINI STOP
AP12	+ DUPĂ CONTACT PROTEJAT SIGURANȚĂ LUNETĂ SPATE CU DEZGHEȚARE
AP22	+ DUPĂ CONTACT PROTEJAT SIGURANȚĂ SCAUN CU ÎNCĂLZIRE
AP29	+ DUPĂ CONTACT PROTEJAT SIGURANȚĂ FUNCȚIE MOTOR SECURITATE
AP30	+ DUPĂ CONTACT PROTEJAT SIGURANȚĂ MACARA GEAM PASAGER
AP39	+ DUPĂ CONTACT PROTEJAT SIGURANȚĂ MACARA GEAM ȘOFER
AP5	+ DUPĂ CONTACT PROTEJAT SIGURANȚĂ SISTEM ANTIBLOCARE ROȚI
AP7	+ DUPĂ CONTACT PROTEJAT SIGURANȚĂ ȘTERGĂTOR PARBRIZ
B	+ BATERIE
BC	+ BATERIE PRIN RELEU PRIN ÎNTRERUPERE CIRCUIT
BP1	+ BATERIE PROTEJAT > AER CONDIȚIONAT
BP11	+ BATERIE PROTEJAT > HABITACLU 1
BP13	+ BATERIE PROTEJAT > HABITACLU 3
BP14	+ BATERIE PROTEJAT > SISTEM ANTIBLOCARE ROȚI
BP16	+ BATERIE PROTEJAT > PROIECTOARE ADIȚIONALE
BP17	+ BATERIE PROTEJAT > INJEȚIE PREÎNCĂLZIRE
BP20	+ BATERIE PROTEJAT SPĂLĂTOR FARURI
BP3	+ BATERIE PROTEJAT BLOCARE ELECTRICĂ UȘI
BP37	+ BATERIE PROTEJAT > MEMORARE INJECTOR > BLOCARE

# REPERTOAR LEGĂTURI

CODURI LEGĂTURI	TITLURI LEGĂTURI
BP56	+ BATERIE PROTEJAT SIGURANȚĂ > CALCULATOR ELECTRONIC
BP7	+ BATERIE PROTEJAT > SIGURANȚĂ 1 GRUP MOTOVENTILATOR
BP88	+ BATERIE PROTEJAT SIGURANȚĂ GRUP HIDRAULIC ABS
BPT	+ BATERIE PROTEJAT TEMPORIZATOR
CPD	+ LUMINI DE ÎNTĂLNIRE PROTEJAT DREAPTA
CPG	+ LUMINI DE ÎNTĂLNIRE PROTEJAT STÂNGA
CSO	+ LUMINI DE ÎNTĂLNIRE UNITATE OPTICĂ SIMPLĂ
D	+ PORNIRE
H1	COMANDĂ- INDICATOR LUMINOS FRÂNĂ DE MÂNĂ > NIVEL DE LICHID DE FRÂNĂ
H17	SEMNAL COD INECȚIE BENZINĂ > DIESEL > ANTIDEMARAJ
H66P	COMANDĂ+ LUMINI DE MERS ÎNAPOI
H7	SEMNAL TUROMETRU>PUNCT MORT SUPERIOR>BOBINĂ>CALCULATOR ELECTRONIC>ALTERNATOR
HK	SEMNAL DIAGNOSTICARE K
HL	SEMNAL DIAGNOSTICARE L
L	+ LUMINI DE POZIȚIE
LPD	+ LUMINĂ DE POZIȚIE DREAPTA PROTEJAT
LPG	+ LUMINĂ DE POZIȚIE STÂNGA PROTEJAT
MA	MASĂ ELECTRICĂ FAȚĂ DREAPTA
MAH	MASĂ ELECTRICĂ SISTEM ANTIBLOCARE ROȚI
MAM	MASĂ ELECTRICĂ TRAVERSĂ PLANȘĂ DE BORD STÂNGA
MAN	MASĂ ELECTRICĂ TRAVERSĂ PLANȘĂ DE BORD DREAPTA
MB	MASĂ ELECTRICĂ FAȚĂ STÂNGA
MF	MASĂ ELECTRICĂ SPATE DREAPTA
MG	MASĂ ELECTRICĂ SPATE STÂNGA
MH	MASĂ ELECTRICĂ MOTOR
ML	MASĂ ELECTRICĂ BATERIE
MT	MASĂ ELECTRICĂ RADIO AUTO
NAP	MASĂ ELECTRONICĂ TUNEL
NC	MASĂ ELECTRONICĂ STÂLP FAȚĂ STÂNGA
NF	MASĂ ELECTRONICĂ MOTOR
R	+ LUMINI DE DRUM
RPD	+LUMINĂ DE DRUM PROTEJAT DREAPTA
RPG	+LUMINĂ DE DRUM PROTEJAT STÂNGA
S	+ ACCESORIU
S1	+ ACCESORIU PRIN RELEU
SP2	+ ACCESORIU PROTEJAT > RADIO AUTO
SP3	+ ACCESORIU PROTEJAT > ÎNCĂLZIRE
TB1	TRESĂ DE ECRANARE SENZOR DETONAȚIE

# REPERTOAR MASE

CODURI MASE	TITLURI MASE
MA	MASĂ ELECTRICĂ FAȚĂ DREAPTA
MAH	MASĂ SISTEM ANTIBLOCARE ROȚI
MAM	MASĂ ELECTRONICĂ TRAVERSĂ PLANȘĂ DE BORD STÂNGA
MAN	MASĂ ELECTRICĂ TRAVERSĂ PLANȘĂ DE BORD DREAPTA
MB	MASĂ ELECTRICĂ FAȚĂ STÂNGA
MC	MASĂ CUTIE DE VITEZE AUTOMATĂ
MF	MASĂ ELECTRICĂ SPATE DREAPTA
MG	MASĂ ELECTRICĂ SPATE STÂNGA
MH	MASĂ ELECTRICĂ MOTOR
ML	MASĂ ELECTRICĂ BATERIE
MT	MASĂ ELECTRICĂ RADIO AUTO
NAP	MASĂ ELECTRONICĂ TUNEL
NC	MASĂ ELECTRONICĂ STÂLP FAȚĂ STÂNGA
NF	MASĂ ELECTRONICĂ MOTOR

# REPERTOAR RACORDĂRI

CODURI RACORDĂRI	TITLURI RACORDĂRI
R2	RACORDARE PLANȘĂ DE BORD/SPATE STÂNGA
R122	RACORDARE CABLAJ PLANȘĂ DE BORD / PROIECTOARE DE CEAȚĂ
R146	RACORDARE CABLAJ PLANȘĂ DE BORD / SCAUNE FAȚĂ
R164	RACORDARE GRUP MOTOVENTILATOR/ PLANȘĂ DE BORD
R212	RACORDARE MOTOR/HABITACLU (MONOBLOC)
R292	HABITACLU /AIRBAG PASAGER
R383	RACORDARE HABITACLU/DIFUZOR RADIO TELEFON



# REPERTOAR ORGANE

CODURI ORGANE	TITLURI ORGANE
101	BRICHETĂ
103	ALTERNATOR
104	CONTACTOR DEMARAJ
105	AVERTIZOR ELECTROMAGNETIC PRINCIPAL
107	BATERIE
118	UNITATE DE CONTROL ELECTRIC SISTEM ANTIBLOCARE ROȚI
120	UNITATE DE CONTROL ELECTRIC INJEȚIE
123	COMANDĂ BLOCARE ELECTRICĂ UȘI
125	COMANDĂ LUMINI DE AVARIE
128	COMANDĂ LUNETĂ SPATE CU DEZGHEȚARE
130	COMANDĂ MACARA ELECTRICĂ GEAM SPATE DREAPTA
131	COMANDĂ MACARA ELECTRICĂ GEAM SPATE STÂNGA
132	COMANDĂ MACARA ELECTRICĂ GEAM ȘOFER
133	COMANDĂ MACARA ELECTRICĂ GEAM PASAGER
134	COMANDĂ RETROVIZOR ELECTRIC
135	COMANDĂ BLOCARE MACARA ELECTRICĂ GEAM SPATE
138	BLOCARE ELECTRICĂ UȘĂ SPATE DREAPTA
139	BLOCARE ELECTRICĂ UȘĂ SPATE STÂNGA
140	BLOCARE ELECTRICĂ UȘĂ ȘOFER
141	BLOCARE ELECTRICĂ UȘĂ PASAGER
145	ANSAMBLU COMBINAT SPĂLĂTOR ȘTERGĂTOR GEAM
146	SENZOR DETONAȚIE 1
147	SENZOR PRESIUNE ATMOSFERICĂ
149	SENZOR PUNCT MORT SUPERIOR
150	SENZOR ROATĂ SPATE DREAPTA
151	SENZOR ROATĂ SPATE STÎNGA
152	SENZOR ROATĂ FAȚĂ DREAPTA
153	SENZOR ROATĂ FAȚĂ STÂNGA
154	CONTACTOR PORTBAGAJ
155	CONTACTOR LUMINI DE MERS ÎNAPOI
156	CONTACTOR FRÂNĂ DE MÂNĂ
160	CONTACTOR LUMINĂ STOP
161	CONTACTOR COMPARTIMENT DE DEPOZITARE PASAGER
163	DEMAROR
164	DISPOZITIV DE SUFLARE AER RECE
165	LAMPĂ ILUMINARE PORTBAGAJ
168	LAMPĂ ILUMINARE COMPARTIMENT DE DEPOZITARE
171	AMBREIERE AER CONDIȚIONAT
172	LAMPĂ SPATE DREAPTA
173	LAMPĂ SPATE STÂNGA
176	PROIECTOR DE CEAȚĂ FAȚĂ DREAPTA
177	PROIECTOR DE CEAȚĂ FAȚĂ STÂNGA
178	CONTACTOR PE CADRUL UȘII SPATE DREAPTA
179	CONTACTOR PE CADRUL UȘII SPATE STÂNGA
180	CONTACTOR PE CADRUL UȘII ȘOFER
181	CONTACTOR PE CADRUL UȘII PASAGER
184	LUMINĂ DE POZIȚIE DREAPTA
185	LUMINĂ DE POZIȚIE STÂNGA
188	GRUP MOTOVENTILATOR DE RĂCIRE
189	DIFUZOR SPATE DREAPTA
190	DIFUZOR SPATE STÂNGA
191	DIFUZOR UȘĂ FAȚĂ DREAPTA
192	DIFUZOR UȘĂ FAȚĂ STÂNGA

# REPERTOAR ORGANE

CODURI ORGANE	TITLURI ORGANE
193	INJECTOR 1
194	INJECTOR 2
195	INJECTOR 3
196	INJECTOR 4
200	LUNETĂ SPATE CU DEZGHEȚARE
201	MOTOR MACARA GEAM SPATE DREAPTA
202	MOTOR MACARA GEAM SPATE STÂNGA
203	MOTOR MACARA GEAM ȘOFER
204	MOTOR MACARA GEAM PASAGER
205	MANOCONTACT
207	SENZOR NIVEL MINIM LICHID DE FRÂNĂ
209	MONOMANETĂ
212	MOTOR ȘTERGĂTOR GEAM FAȚĂ
219	POMPĂ SPĂLĂTOR FAR
221	POMPĂ SPĂLĂTOR GEAM FAȚĂ
222	POTENȚIOMETRU CLAPETĂ FLUTURE
224	PRESOSTAT DIRECȚIE ASISTATĂ
225	PRIZĂ DE DIAGNOSTICARE
226	FAR DREAPTA
227	FAR STÂNGA
233	RELEU DISPOZITIV DE SUFLARE AER RECE
239	RETROVIZOR ELECTRIC ȘOFER
240	RETROVIZOR ELECTRIC PASAGER
242	SONDĂ DE OXIGEN AVAL
244	SENZOR TEMPERATURĂ APĂ INECȚIE
247	TABLOU DE BORD
250	SENZOR VITEZĂ VEHICUL
255	LUMINĂ SEMNALIZARE FAȚĂ DREAPTA
256	LUMINĂ SEMNALIZARE FAȚĂ STÂNGA
261	RADIO AUTO
262	GRUP MOTOVENTILATOR DE RĂCIRE ȘI AER CONDIȚIONAT
267	LAMPĂ SEMNALIZARE DREAPTA
268	LAMPĂ SEMNALIZARE STÂNGA
272	SENZOR TEMPERATURĂ AER INECȚIE
299	PLATINĂ ACCESORII RELEE
319	TABLOU DE COMANDĂ AER CONDIȚIONAT
321	REZISTENȚĂ GRUP MOTOVENTILATOR AER CONDIȚIONAT
322	DIODĂ AER CONDIȚIONAT ȘI DIRECȚIE ASISTATĂ
336	RELEU VITEZA 2 GRUP MOTOVENTILATOR
371	ABSORBANT VAPORI DE BENZINĂ
529	PLAFONIERĂ CENTRALĂ
597	CUTIE SIGURANȚE MOTOR ȘI RELEE
639	LAMPĂ STOP SUPRAÎNĂLȚATĂ
645	UNITATE DE CONTROL ELECTRICĂ HABITACLU
649	MOTOR PAS CU PAS
689	COMANDĂ REGULADOR DE VITEZĂ ȘI AIRBAG
734	COMANDĂ MACARA CU IMPULSURI GEAM ȘOFER
756	UNITATE DE CONTROL ELECTRIC AIRBAG /PRETENSIONATOR
778	MODUL BOBINĂ CVADRUPLĂ APRINDERE
784	BLOC 2 RELEE DE COMANDĂ
833	JOJĂ ȘI POMPĂ DE CARBURANT
861	AIRBAG PASAGER
887	SONDĂ DE OXIGEN AMONTE

# REPERTOAR ORGANE

CODURI ORGANE	TITLURI ORGANE
957	UNITATE TRANSPONDER
967	AVERTIZOR SONOR ELECTROMAGNETIC
1016	CUTIE SIGURANȚE HABITACLU
1047	RELEU INJEȚIE
1202	SENZOR PRESIUNE GAZ DE RĂCIRE
1324	LAMPĂ ILUMINARE NUMĂR DE ÎNMATRICULARE CENTRALĂ
1441	CHEIE INHIBARE AIRBAG PASAGER
1456	COMANDĂ DEZGHEȚARE CU IMPULSURI

# INDEX FUNCȚII

NUMERE PLANȘE	FUNȚII
1 - 8	MASĂ
9 - 10	ASISTENȚĂ LA CONDUCERE
11 - 12	AIRBAG
13	ALARMĂ ȘI ANTIDEMARAJ
14 - 15	BRICHETĂ
16	SISTEM ANTIBLOCARE ROȚI
17 - 18	AVERTIZOR SONOR
19 - 21	CUTIE INTERCONECTĂRI HABITACLU
22 - 25	ÎNCĂLZIRE DE BAZĂ SAU AER CONDIȚIONAT
26	CIRCUIT DE ÎNCĂRCARE BATERIE
27	CIRCUIT DE DEMARAJ
28 - 29	BLOCARE DESCHIDERI MOBILE
30 - 31	DEZGHEȚARE LUNETĂ SPATE
32	ILUMINARE PORTBAGAJ
33 - 35	ILUMINARE PLAFONIERĂ
36	ILUMINARE COMPARTIMENTE DE DEPOZITARE
37	ȘTERGĂTOR GEAM FAȚĂ
38	LUMINI DE CEAȚĂ SPATE
39	PROIECTOARE DE CEAȚĂ FAȚĂ
40 - 41	LUMINI DE ÎNTÂLNIRE
42	LUMINI DE MERS ÎNAPOI
43	LUMINI DE POZIȚIE
44	LUMINI DE DRUM
45	LUMINI STOP
46	LUMINI SEMNALIZARE DIRECȚIE ȘI DE AVARIE
47	INDICARE NIVEL DE CARBURANT
48	INDICARE PRESIUNE ULEI
49 - 54	INJEȚIE ELECTRONICĂ
55	SPĂLĂTOR FARURI
56	MACARALE ELECTRICE GEAMURI SPATE
57 - 58	MACARA ELECTRICĂ GEAM ȘOFER
59 - 65	PLATINĂ SIGURANȚE ȘI RELEE
66 - 67	PRIZĂ DE DIAGNOSTICARE NORMA OBD2
68 - 69	RADIO AUTO ȘI PERIFERIC COMUNICARE
70 - 71	RĂCIRE MOTOR
72	RETROVIZOARE ELECTRICE
73	SCAUNE CU ÎNCĂLZIRE
74 - 77	TABLOU DE BORD
78	MARTOR LUMINOS FRÂNĂ DE MÂNĂ
79	MARTOR LUMINOS NIVEL LICHID DE FRÂNĂ

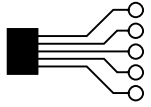

L90/DA/CA

X90  
04

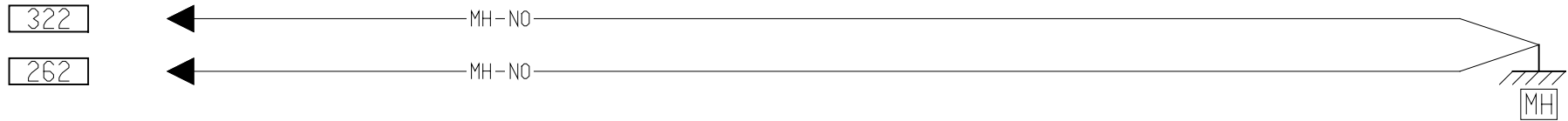
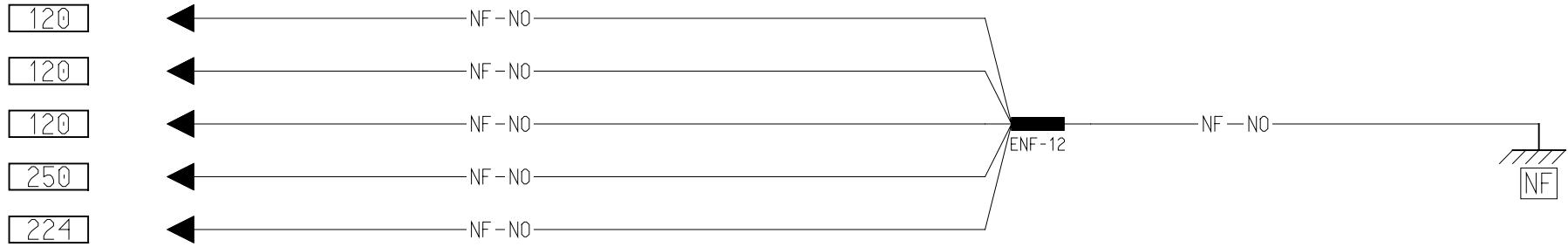

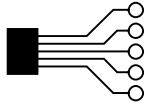

L90/GDFROI,TEMP

X90  
04

107



ML-NO

107



ML-NO



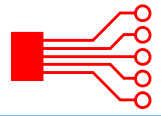

L90/E1/SSABS/SOP02/LVAVEL

X90  
04

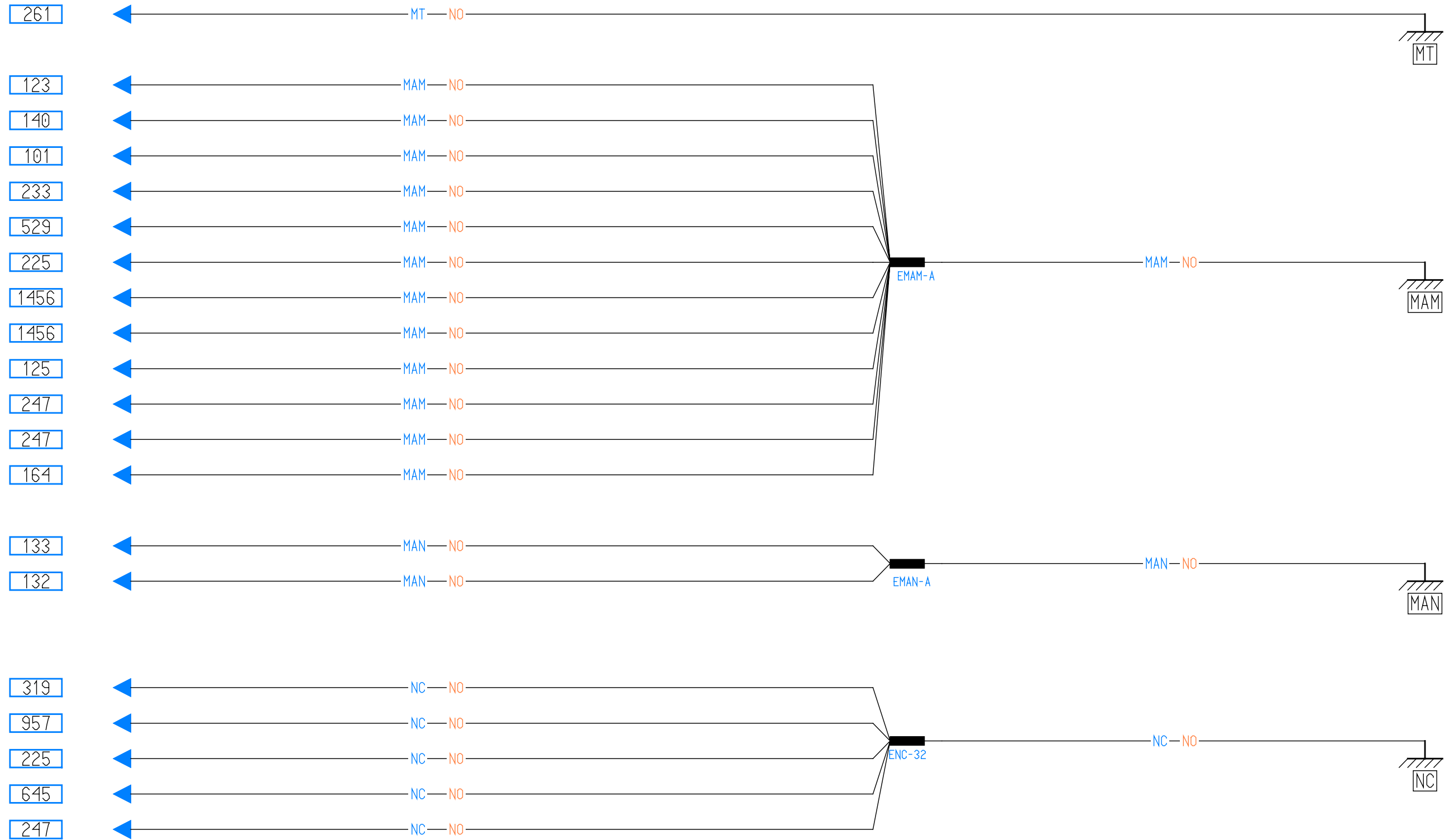

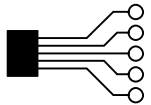

L90/DA/CHAUFO

X90

04

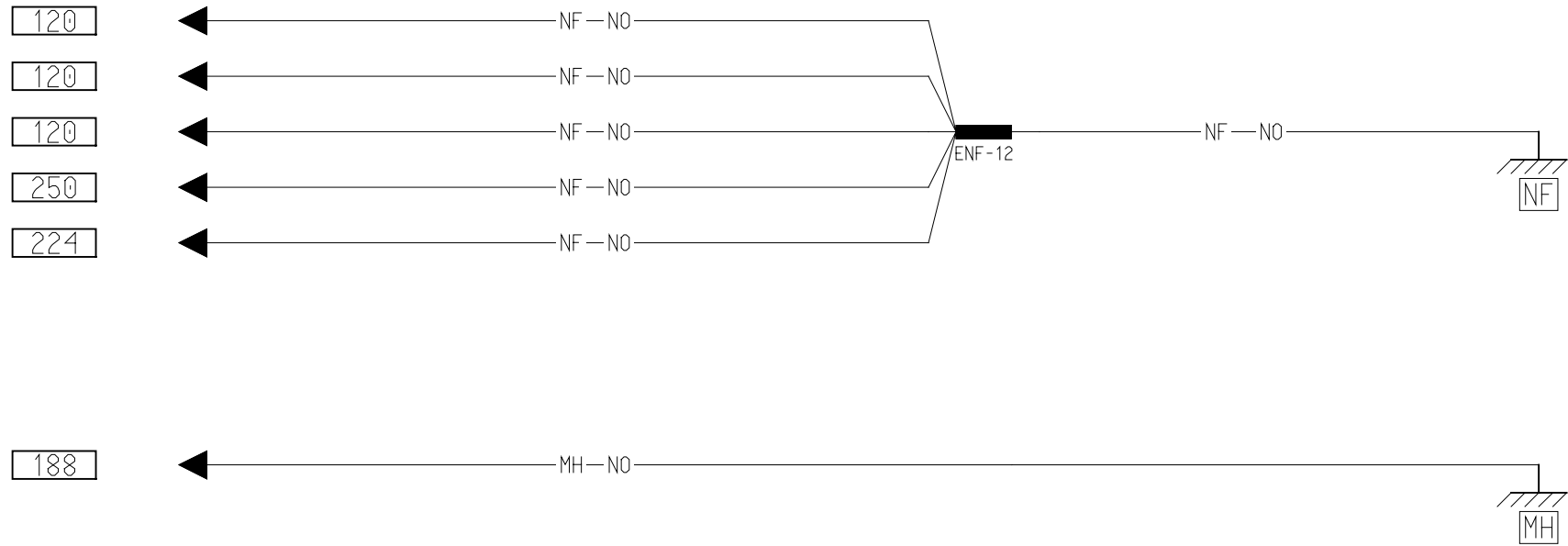



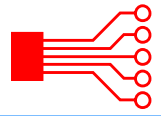

L90/E0/CA/SRADIO

X90  
04

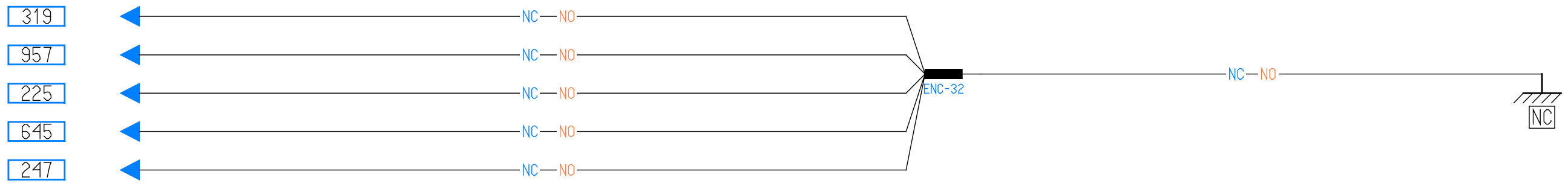
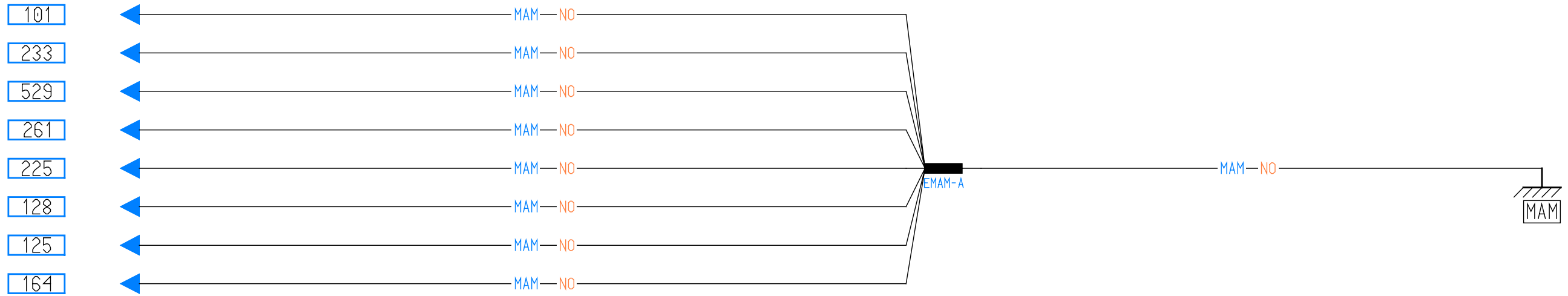

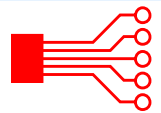

Masa ABS

L90/E2/ABS/RETROE/SOP03/LVCIPE/LVAREL/SGACHA/ABPA01

X90  
04

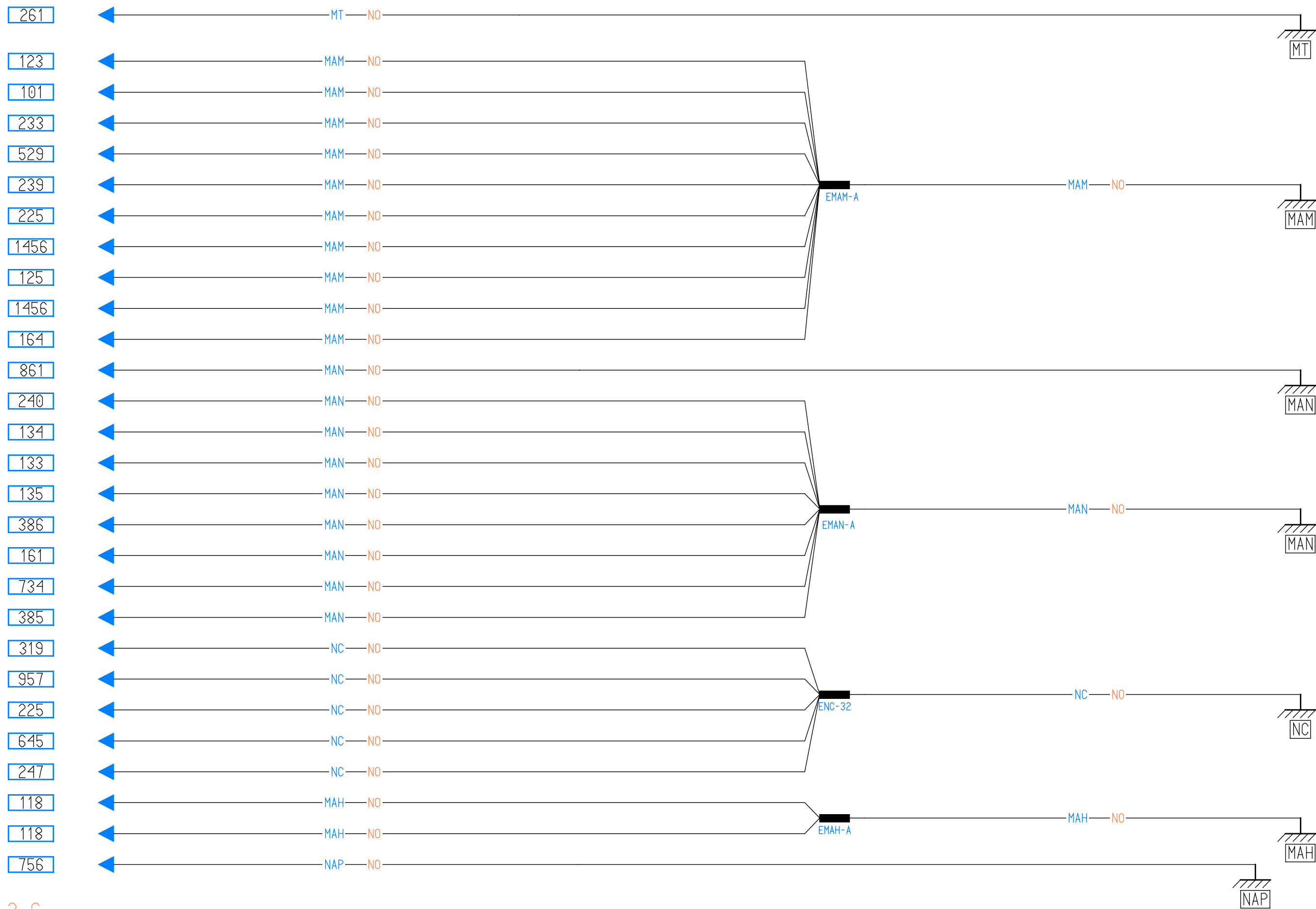

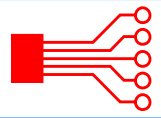

masa electrica fata dreapta

L90/E2/ESS/PROJAB/SOP03/LAVPH

X90  
04

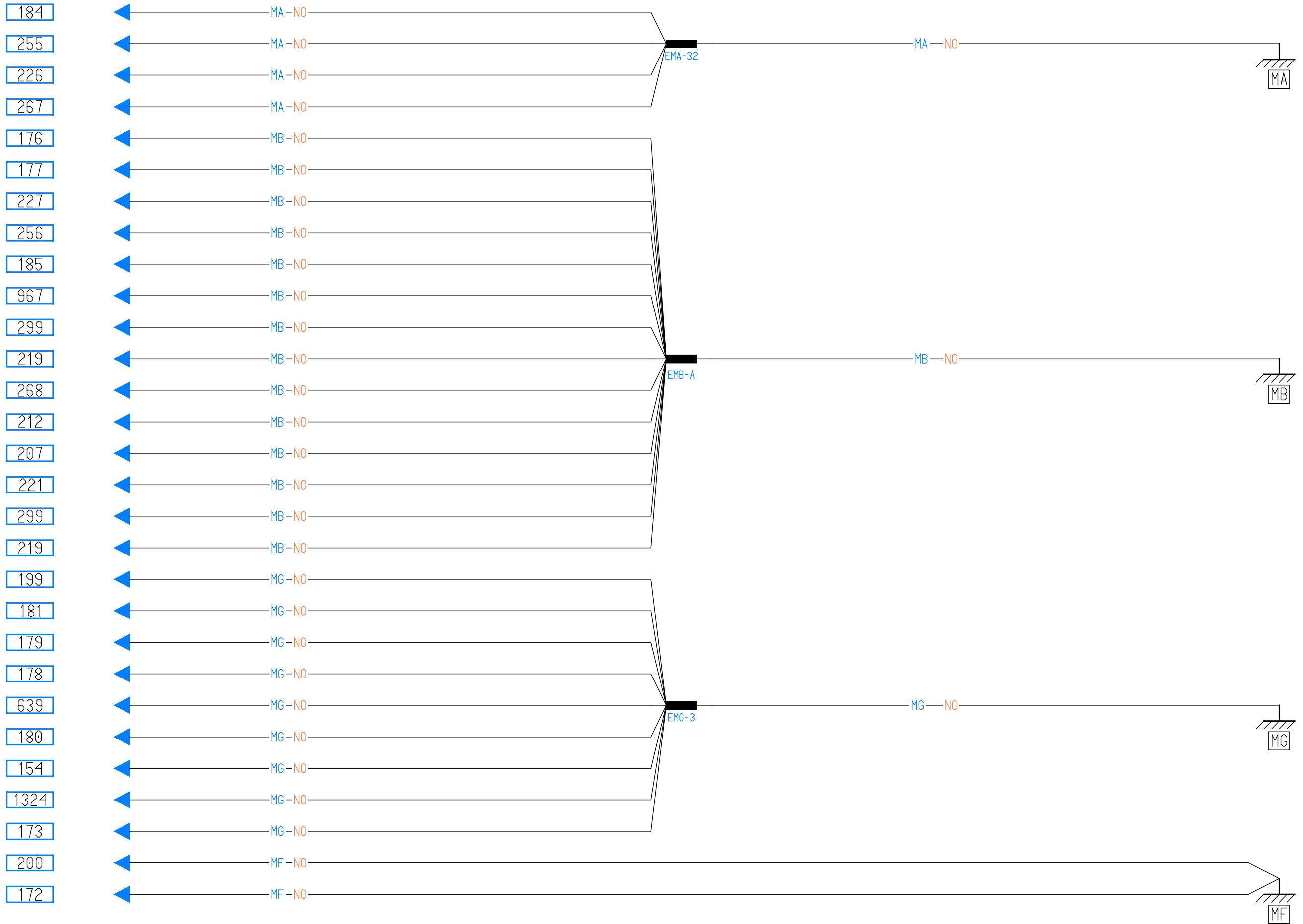

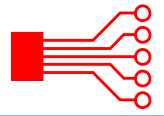

L90/E0/CHAUFO/SGACHA/SRADIO

X90  
04



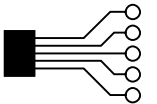

L90/E1,E2

X90

04

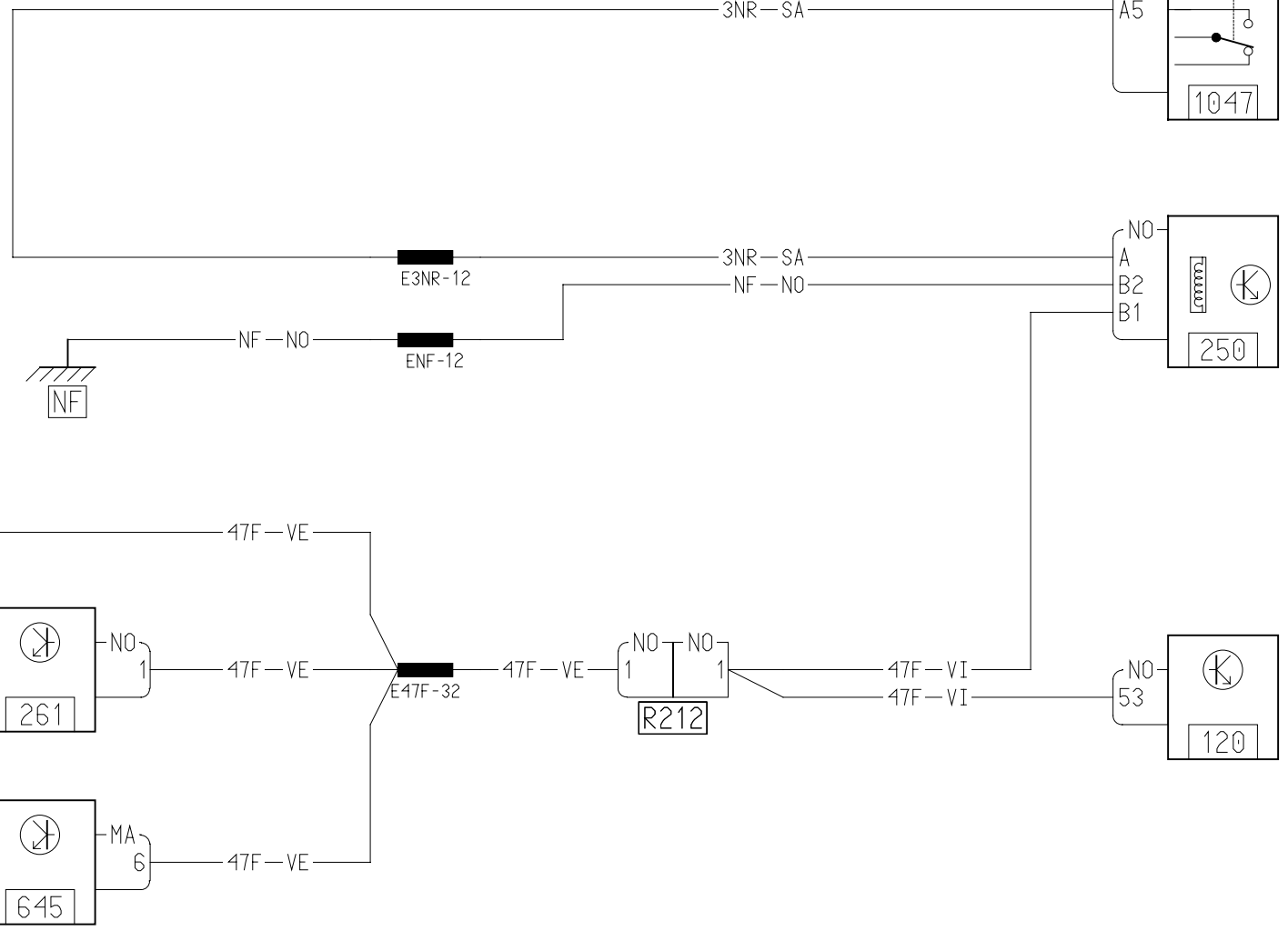
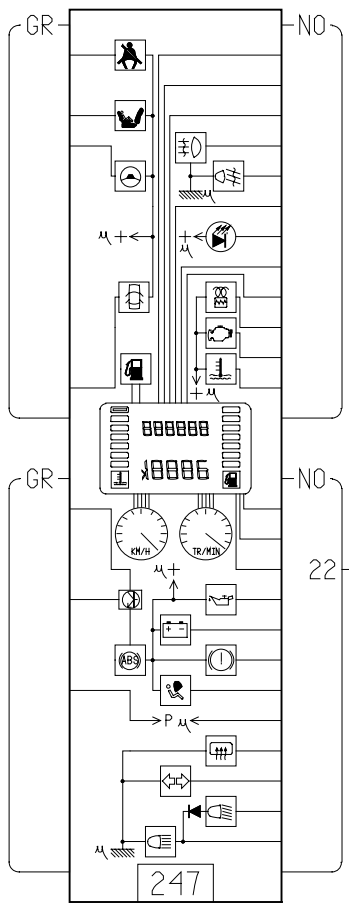

3-9

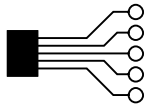

L90

X90

04

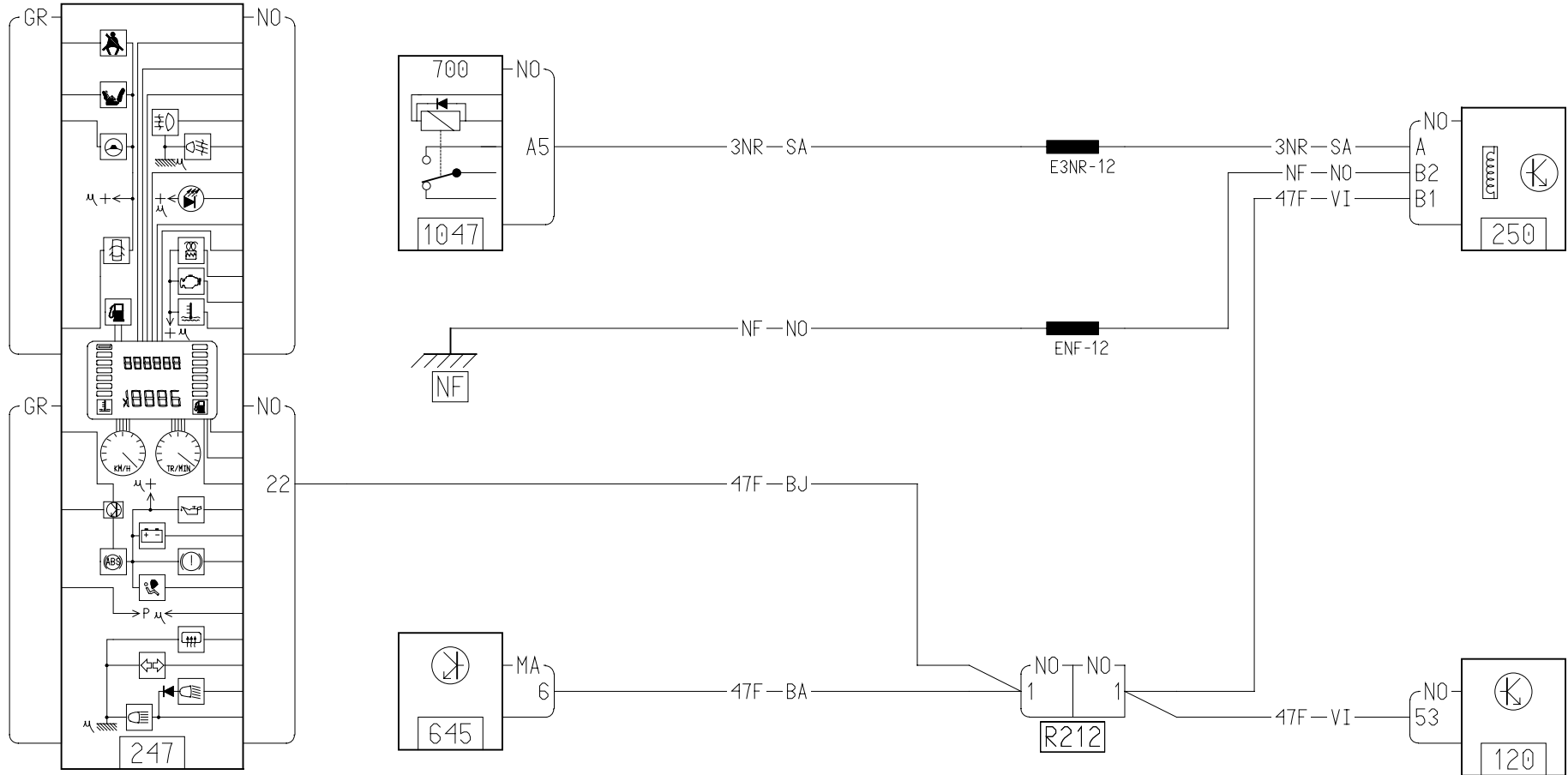

3-10

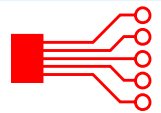

L90/ABPA01/ABC001

X90  
04

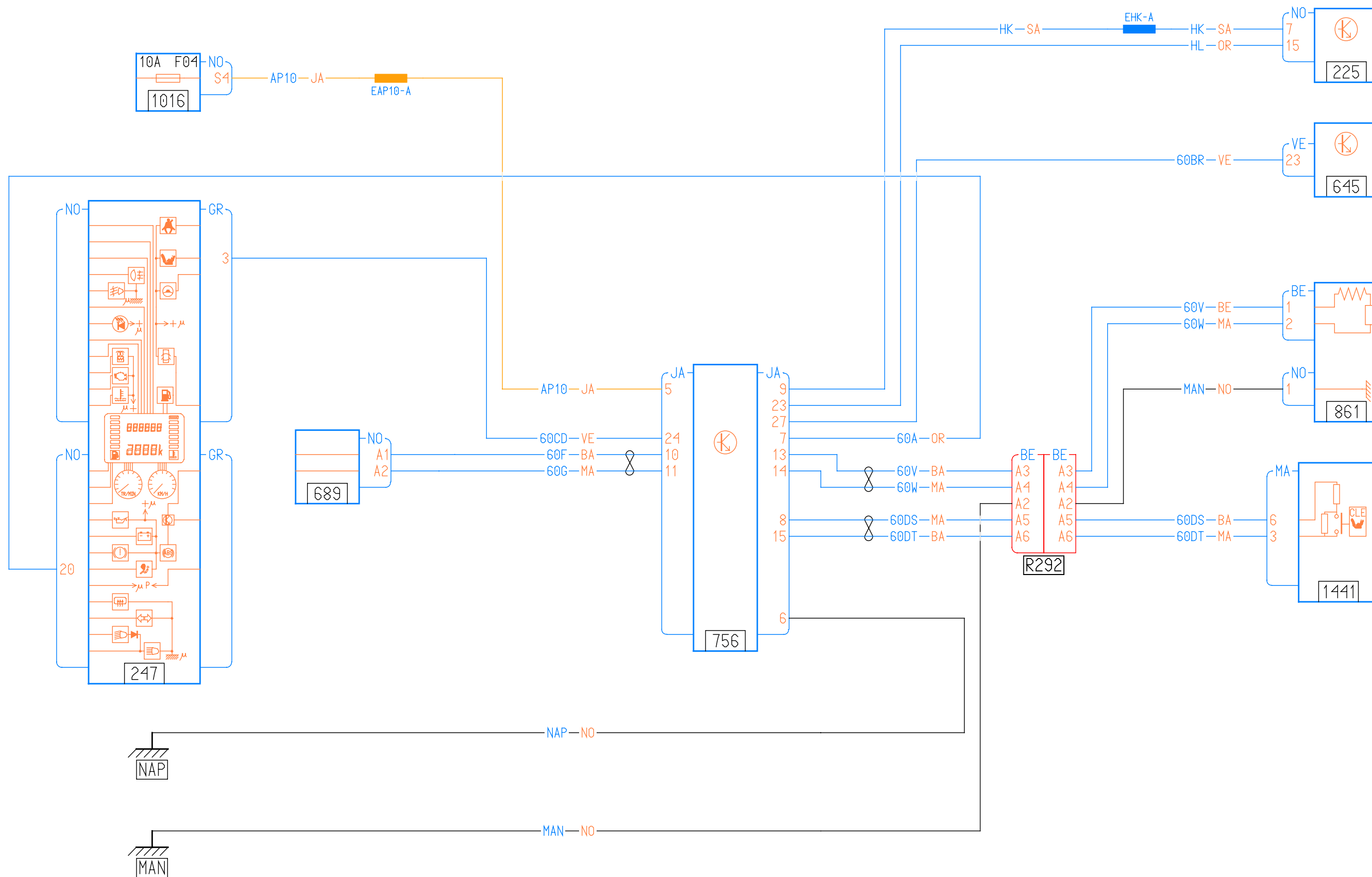

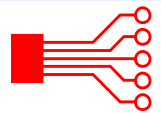

L90/ABC001

X90  
04

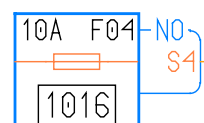

AP10-JA

EAP10-A

AP10-JA

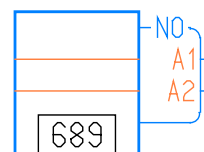

60F-BA

60G-MA

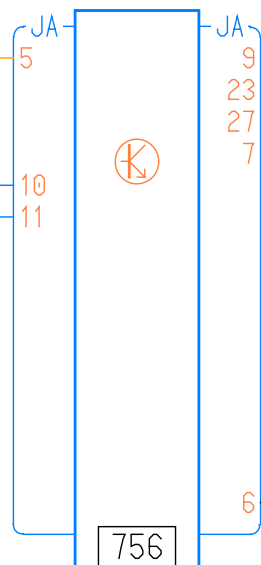

HK-SA EHK-A HK-SA HL-OR

NO  
7  
15

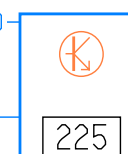

60BR-VE

VE  
23



60A-OR

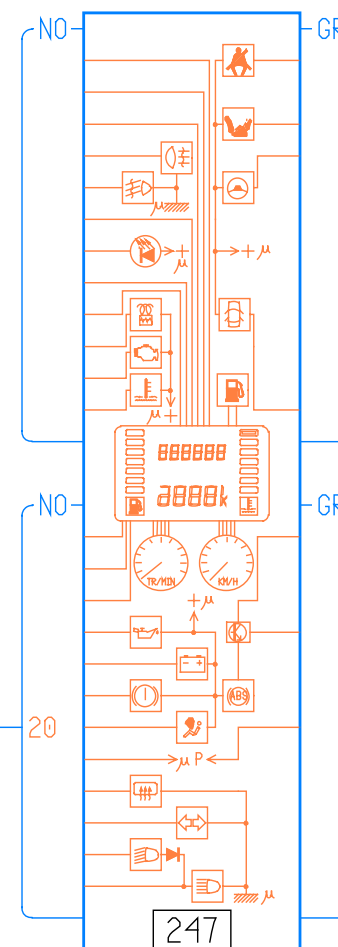

NAP-NO





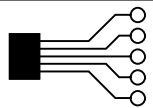

L90

X90  
04

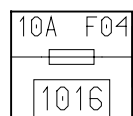

AP10-JA

EAP10-A

AP10-JA

80X-MA

NC-NO

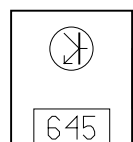
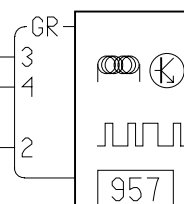

MA

16



NC-NO

ENC-32

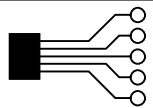

L90/E1,E2

X90  
04

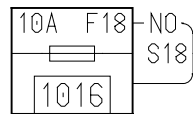
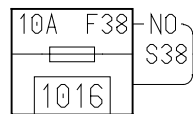
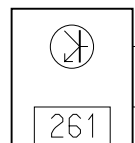

MAM-NO

EMAM-A

LPG-BE

ELPG-A

SP2-JA

SP2-JA

MAM-NO

LPG-BE

NO

2

3

1

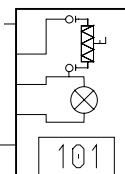

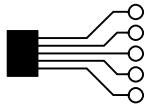

L90

X90

04

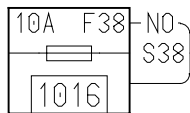
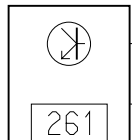

MAM-NO

EMAM-A

SP2-JA

SP2-JA

MAM-NO

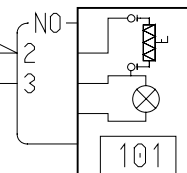

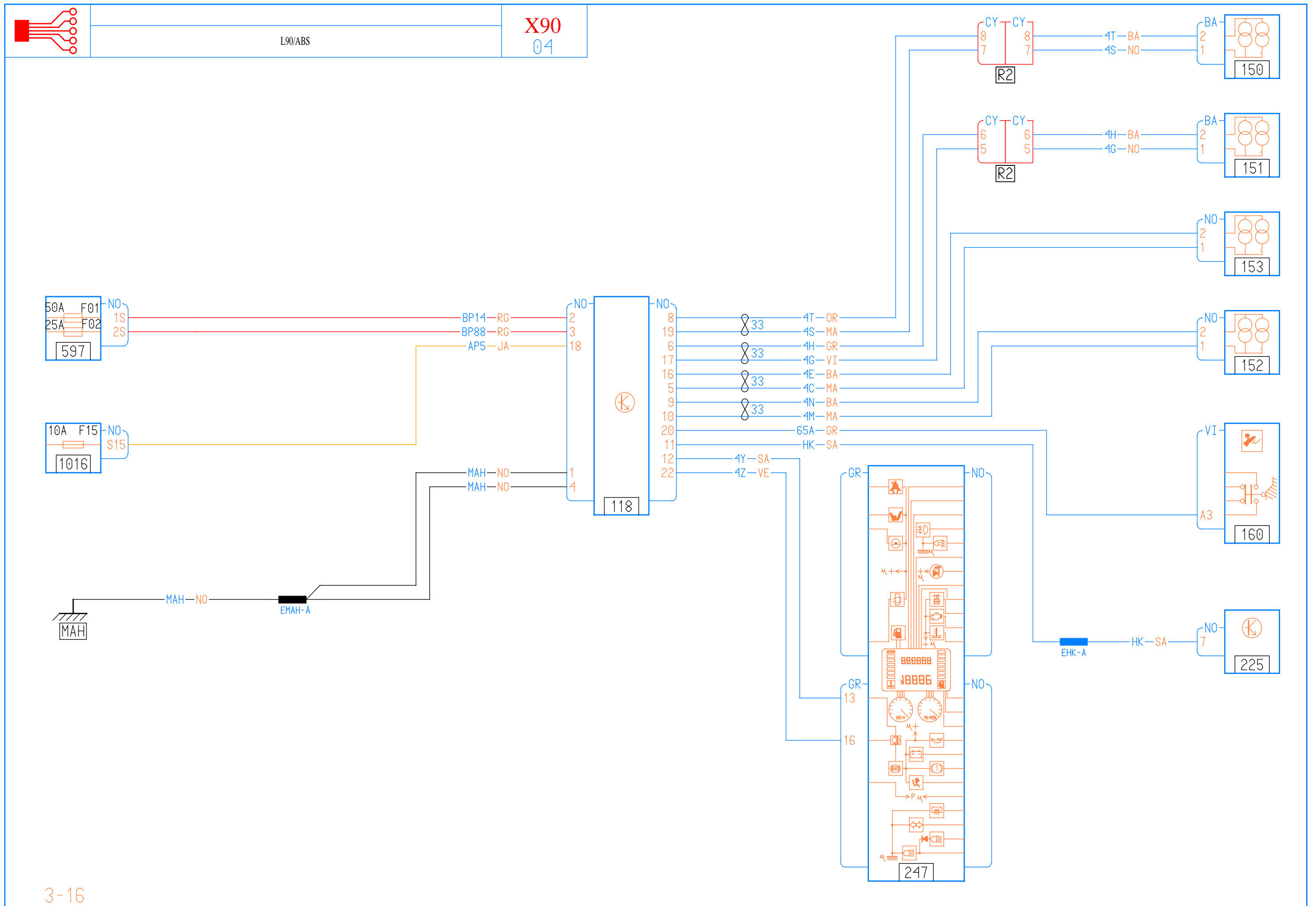

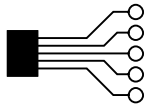

L90

X90

04

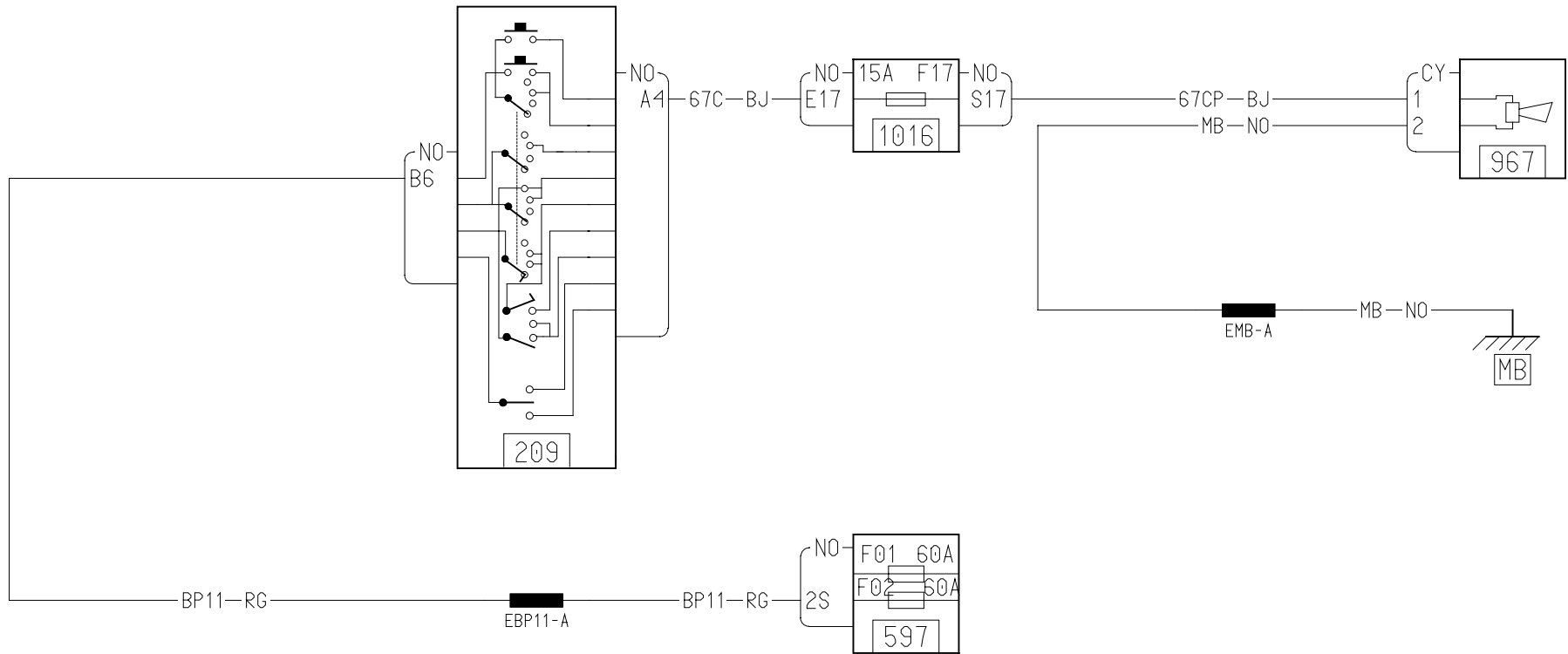

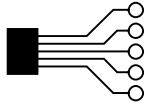

L90/E0,E1

X90

04

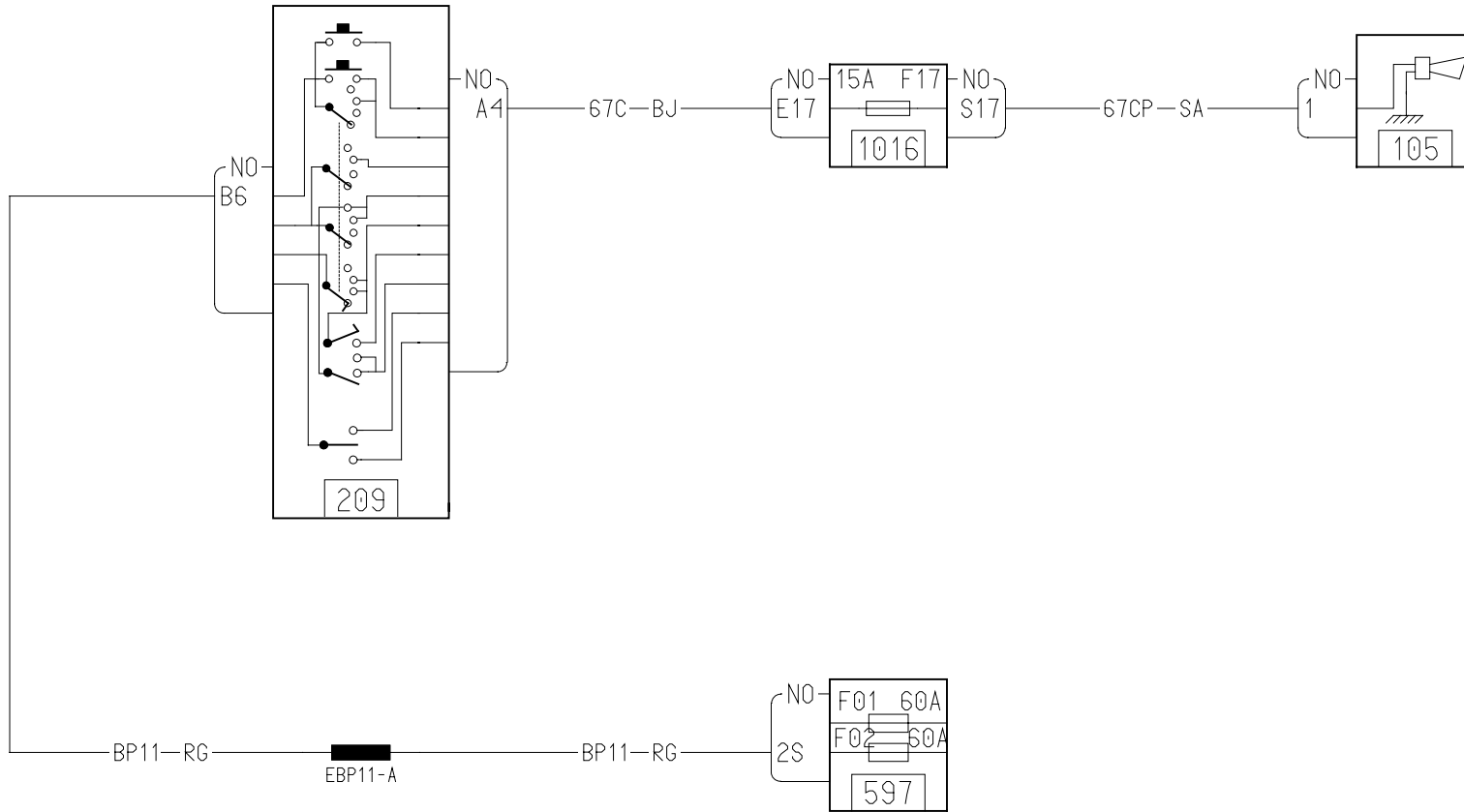

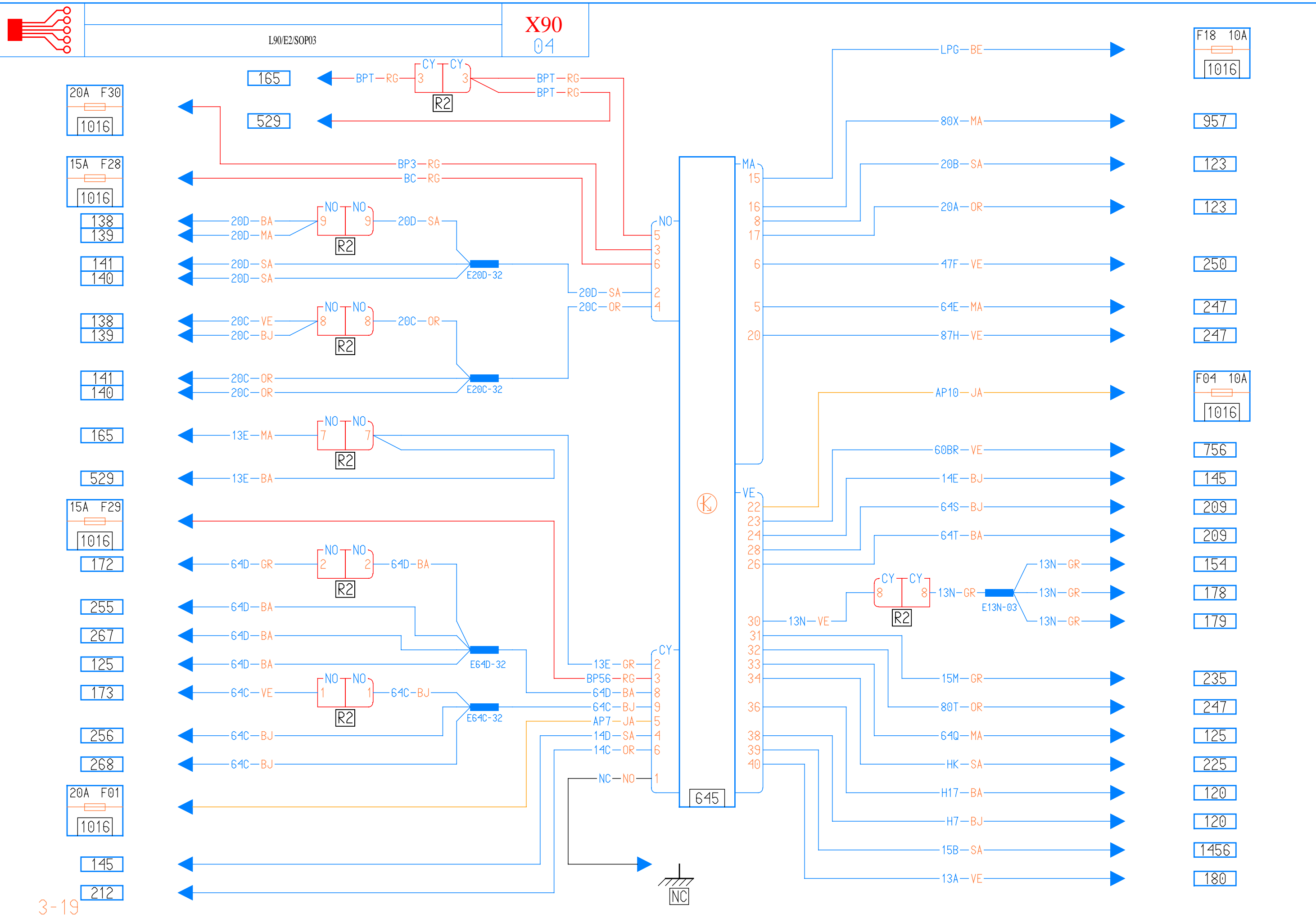

X90  
04

L90/E2/SOP03

20A F30  
1016

15A F28  
1016

138  
139

141  
140

138  
139

141  
140

165

529

15A F29  
1016

172

255

267

125

173

256

268

20A F01  
1016

145

212

F18 10A  
1016

957

123

123

250

247

247

F04 10A  
1016

756

145

209

209

154

178

179

235

247

125

225

120

120

1456

180

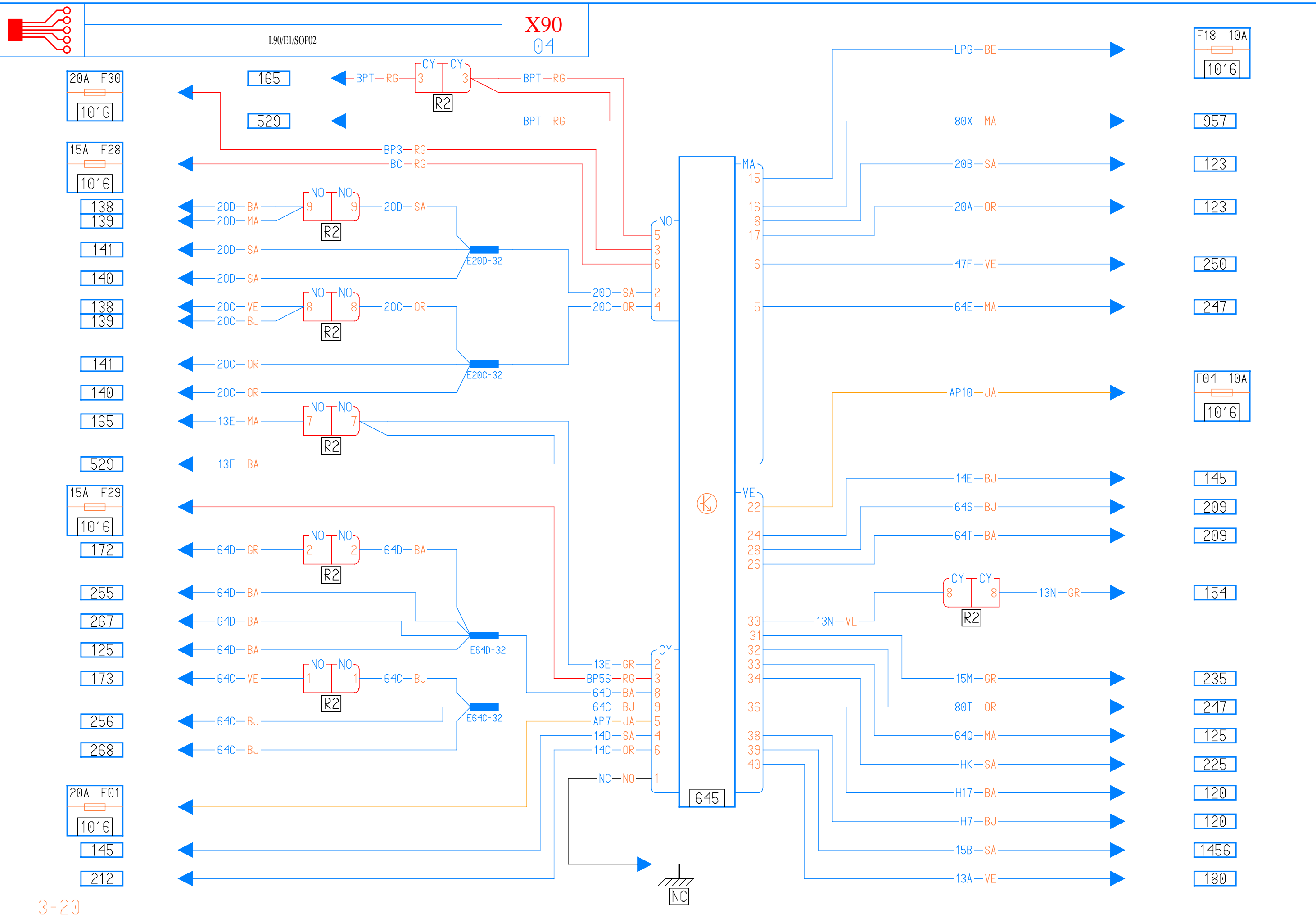



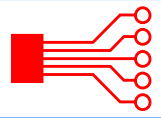

L90/SOP01

X90  
04

529

BPT-RG

15A F28

1016

BC-RG

15A F29

1016

172

64D-GR

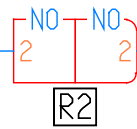

64D-BA

255

64D-BA

267

64D-BA

125

64D-BA

173

64C-VE

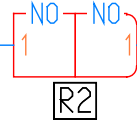

64C-BJ

256

64C-BJ

268

64C-BJ

20A F01

1016

145

212

NO

5

6

CY

3

8

9

5

4

6

1

645

MA

15

16

6

5

VE

22

24

28

26

32

33

34

36

40

LPG-BE

80X-MA

47F-BA

64E-MA

AP10-JA

14E-BJ

64S-BJ

64T-BA

80T-OR

64Q-MA

HK-SA

H17-BA

13A-VE

F18 10A

1016

957

250

247

F04 10A

1016

145

209

209

247

125

225

120

180



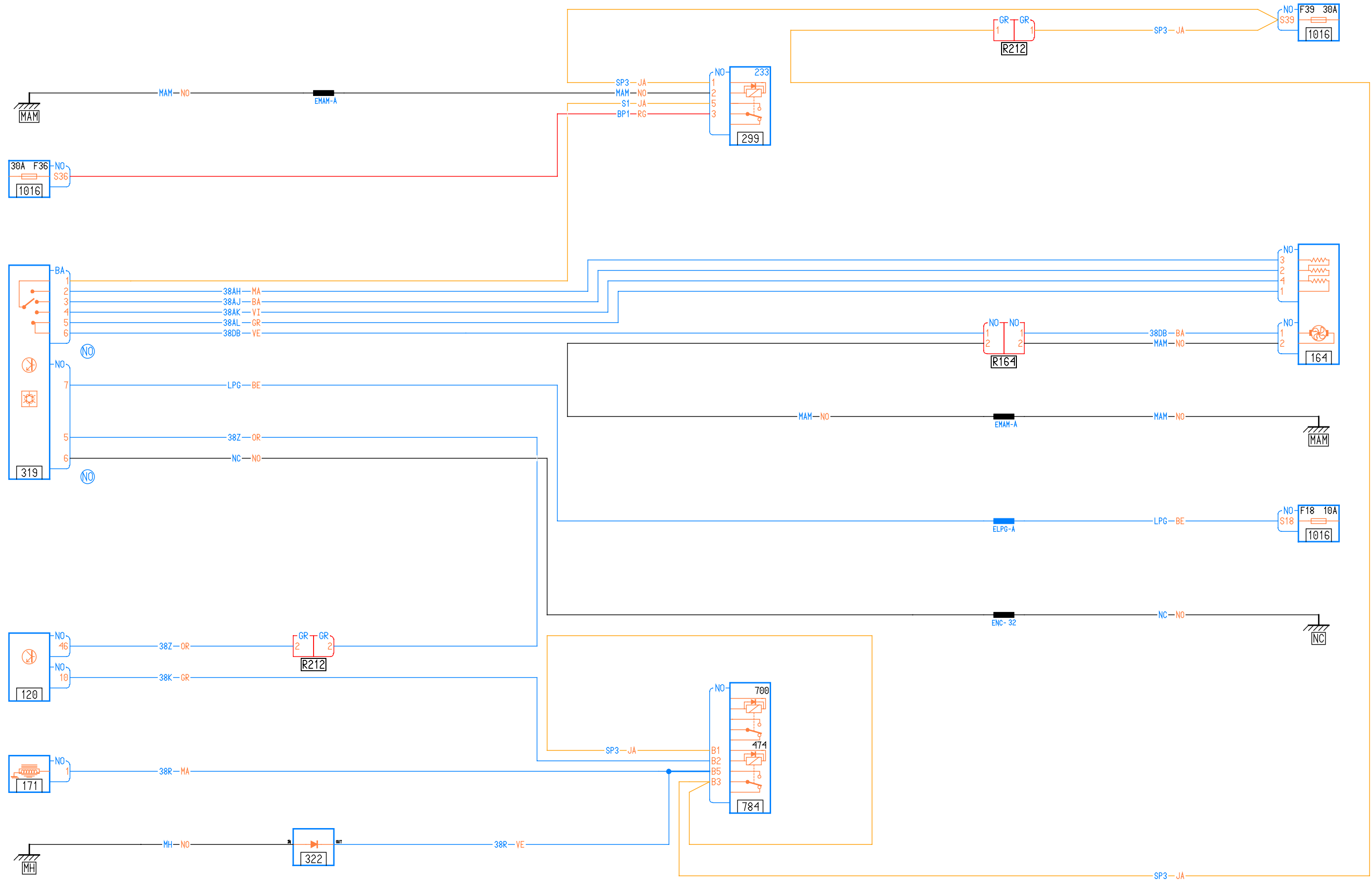

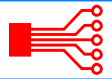

L90/E0/E1/E2/CA

X90  
04

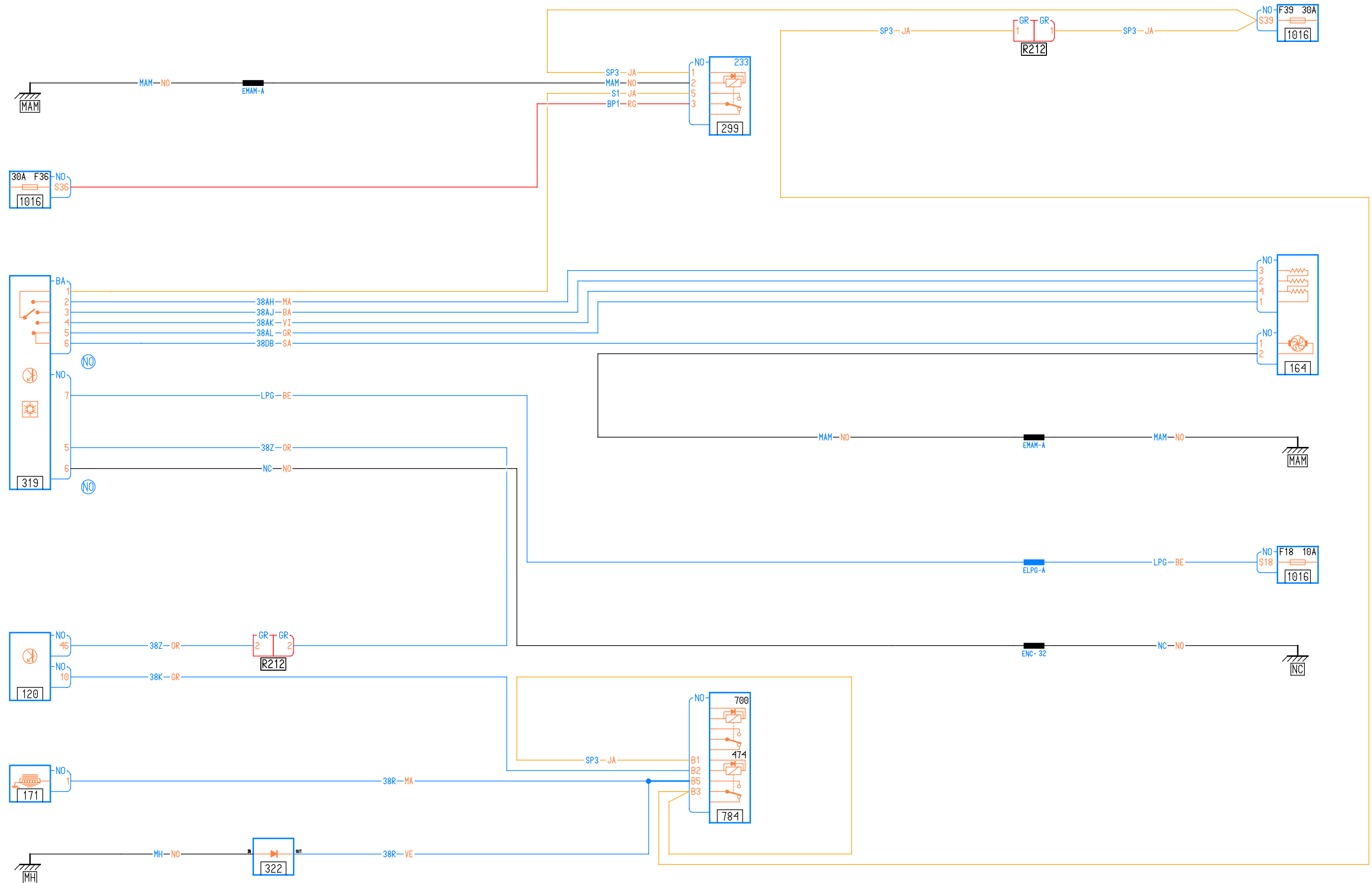

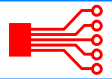

L90/EI/SSABS/CHAUF0/RETROR/SOP02/SSABCO

X90  
04

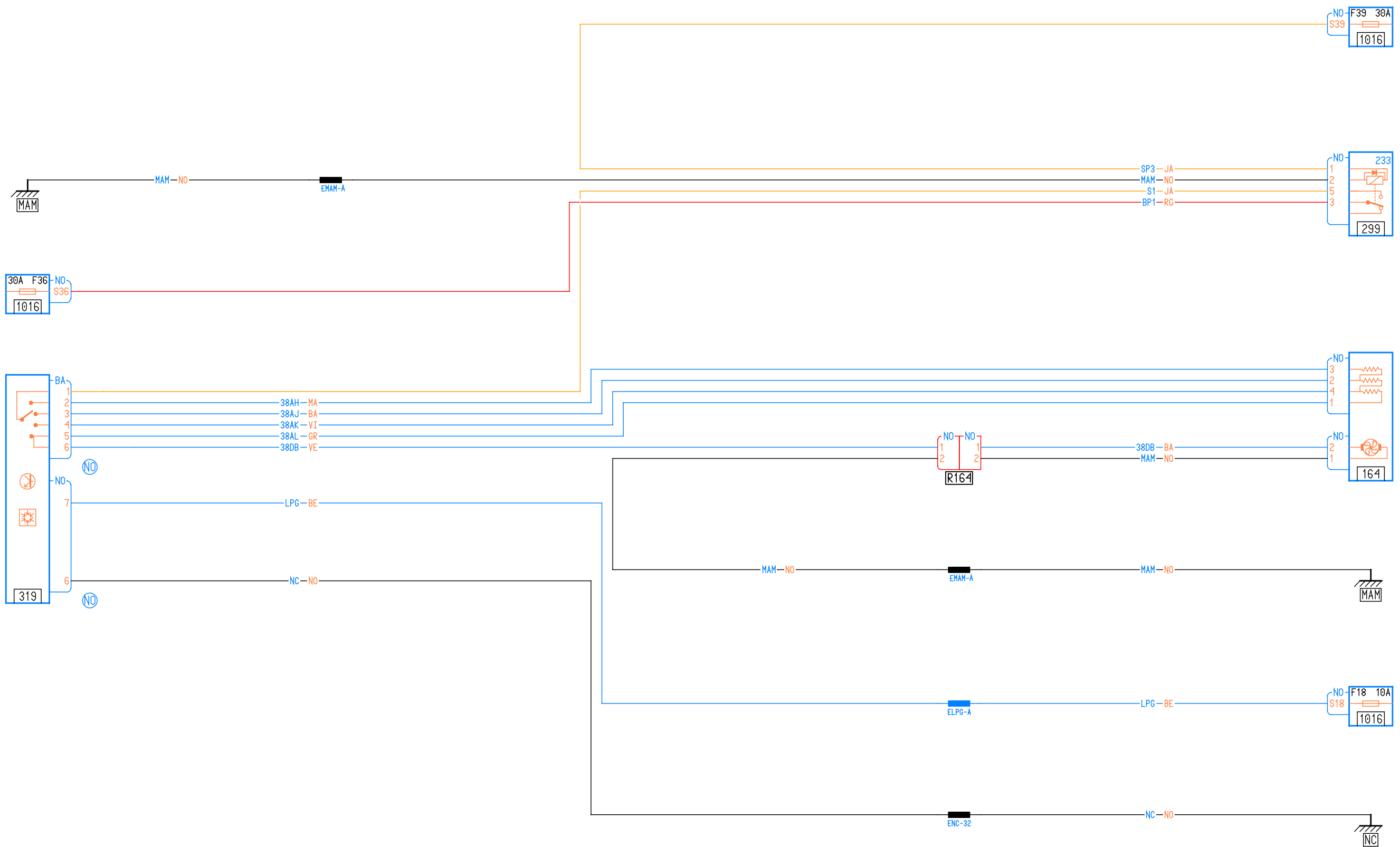

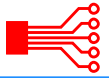

L90E1/SSABS/CHAUF0/RETROR/SOP02/LVAVMA/SSABCO/L90E0/CHAUF0/SSABCO/SRADIO

X90  
04

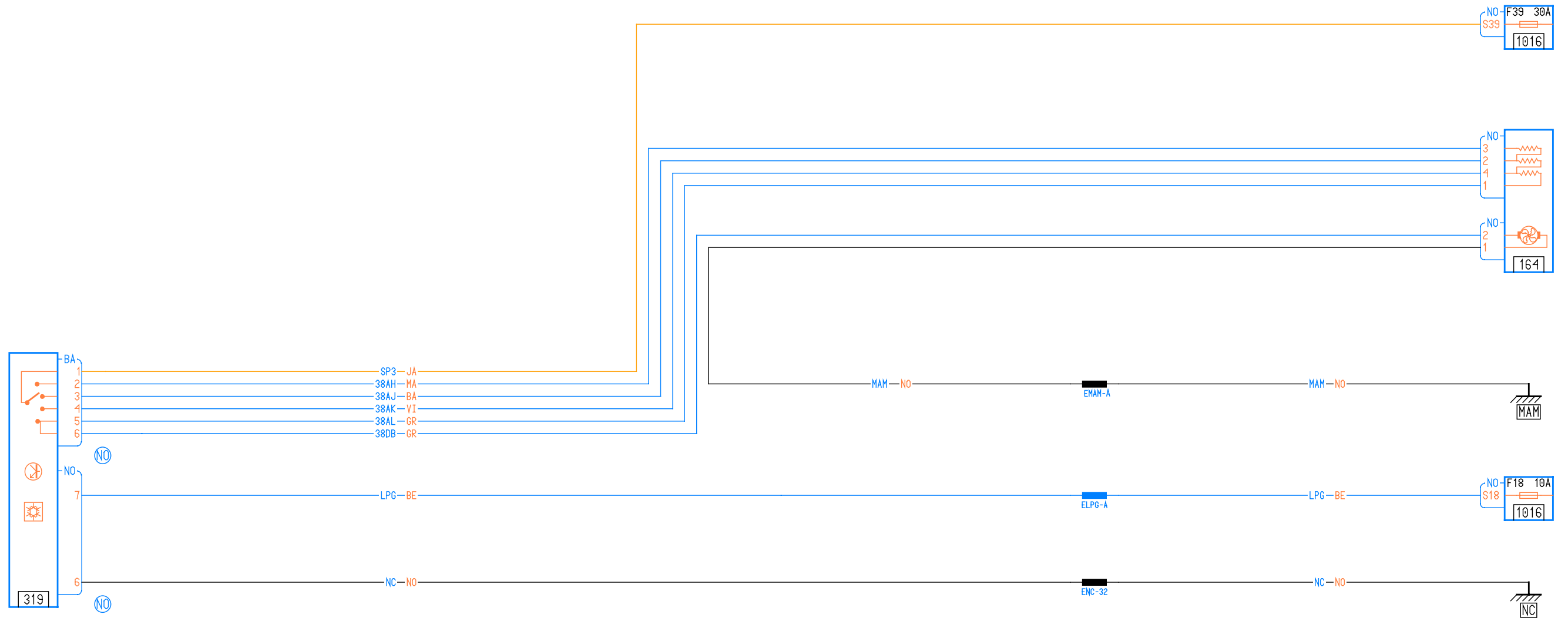

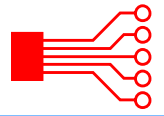

L90/DA,DM/CA,CHAUF0

X90  
04

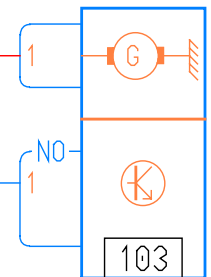
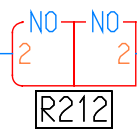
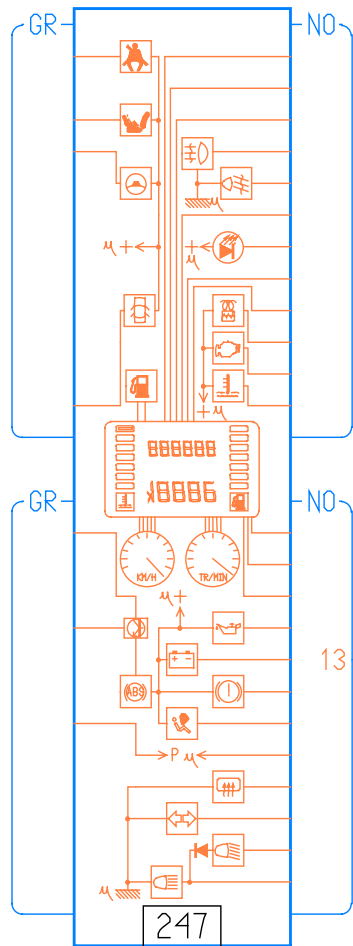
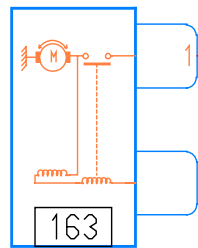

B-RG

2A-BA

2A-OR

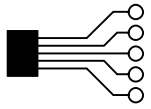

L90/GDFROI,TEMP

X90

04

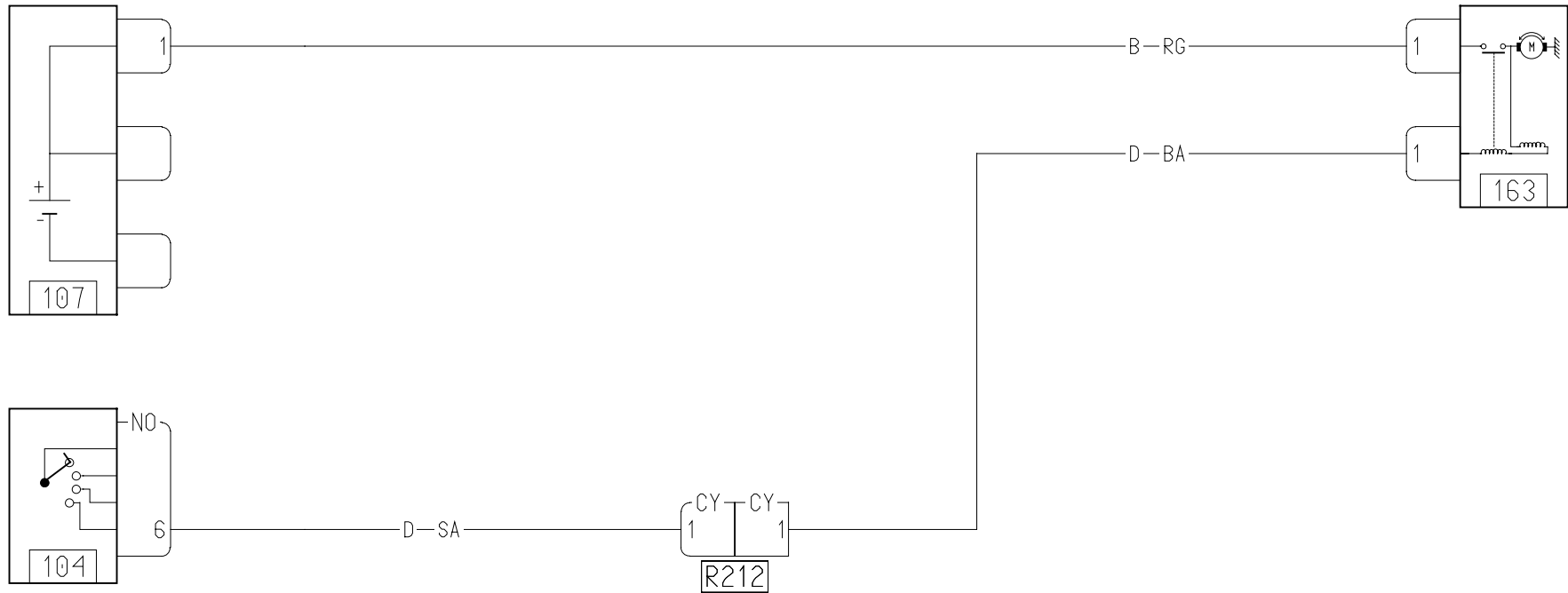
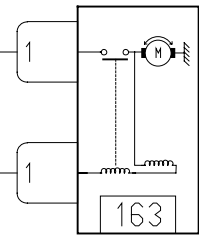
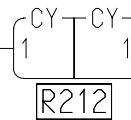
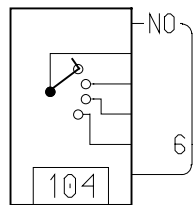
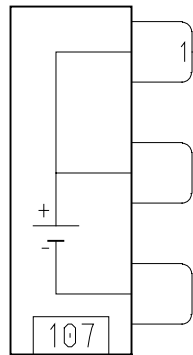

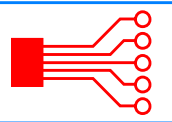

L90/SOP03

X90  
04

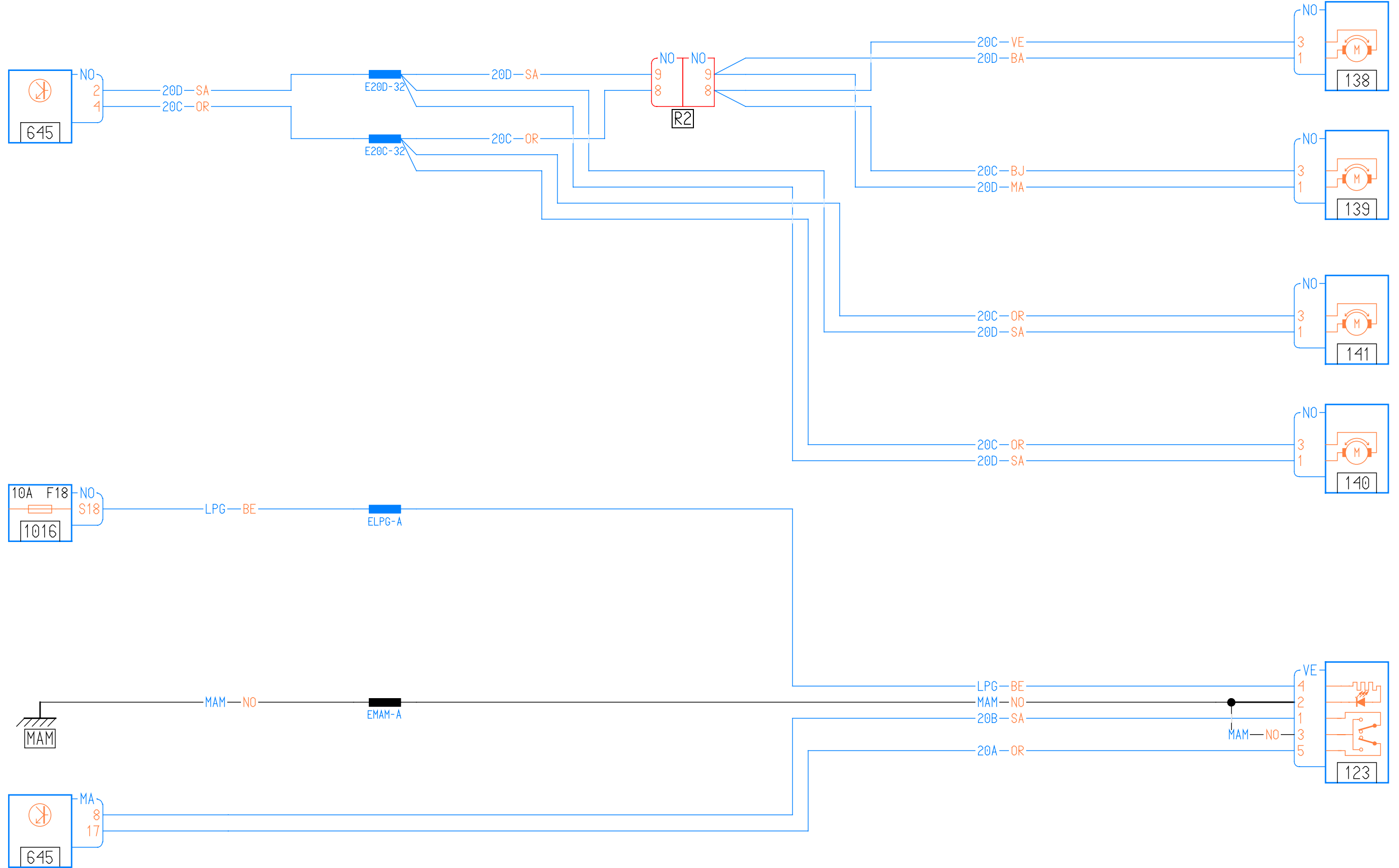



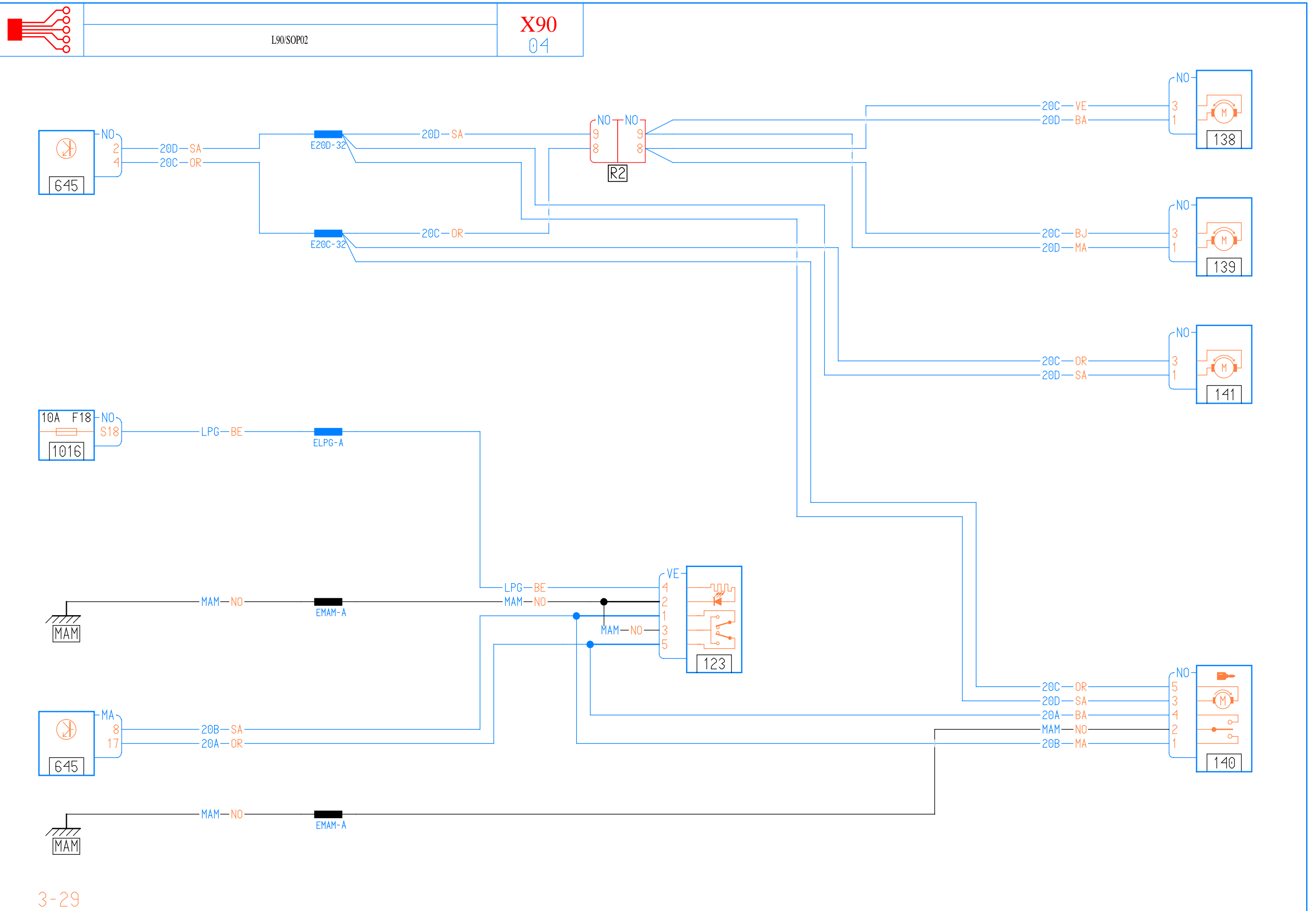

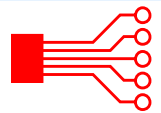

L90/E2/RETROE

X90  
04

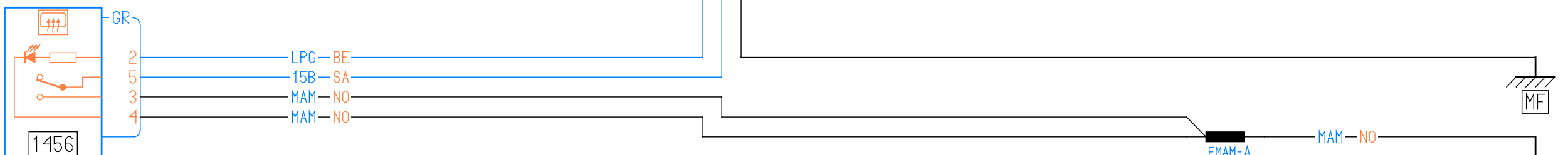
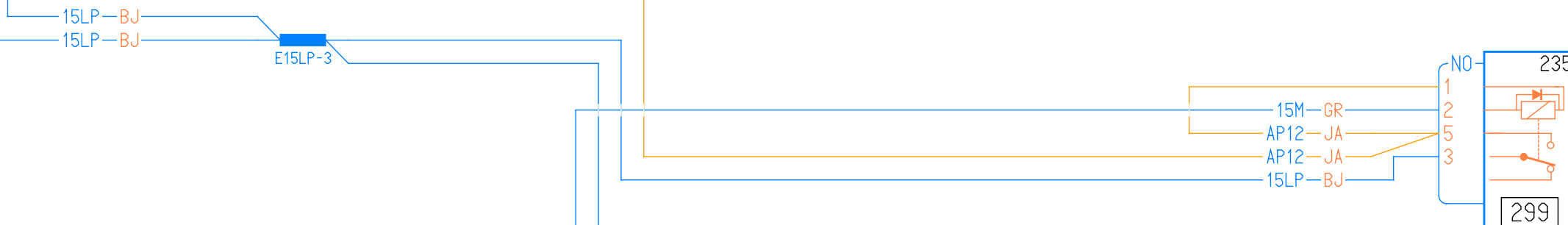
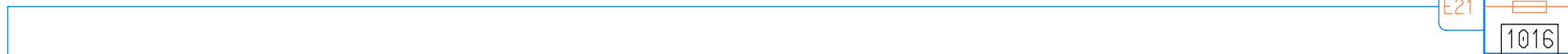
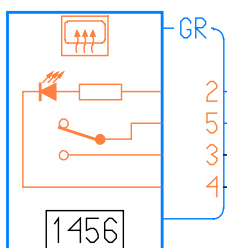
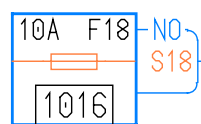
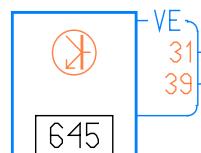
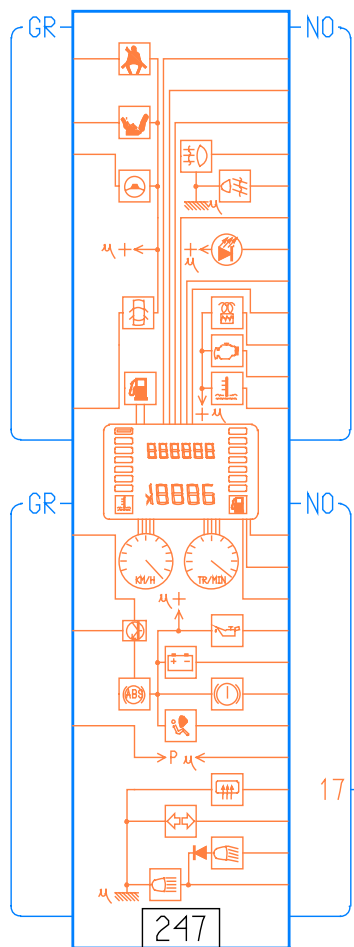

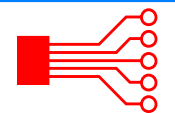

L90/E0

X90  
04

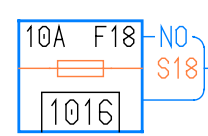

LPG-BE

ELPG-A

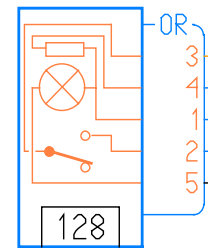
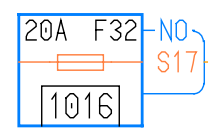

AP12-JA

LPG-BE

15A-BJ

15LP-BJ

MAM-NO

MAM-NO

EMAM-A

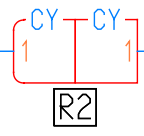

15LP-BA

MF-NO

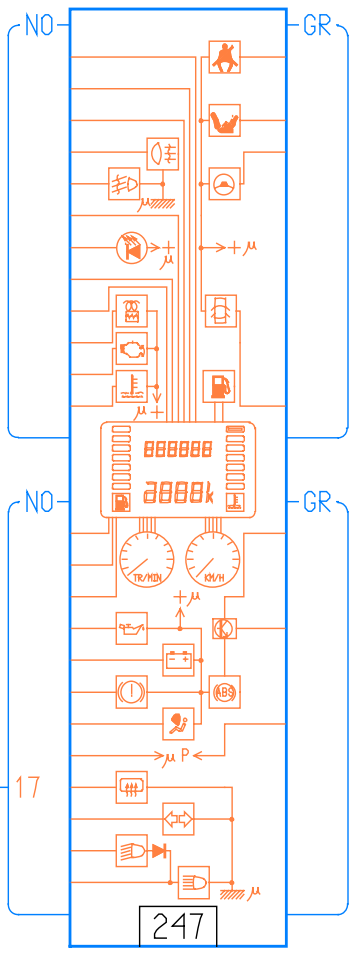

17



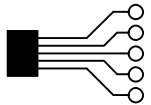

L90

X90  
04

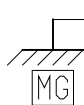
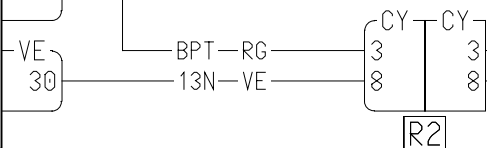
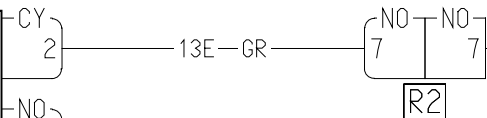
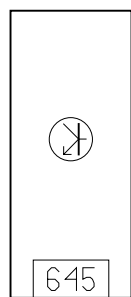

E13N-03

EMG-3

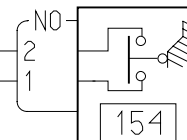
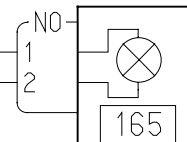

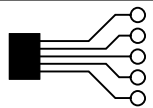

L90/SOP03

X90

04

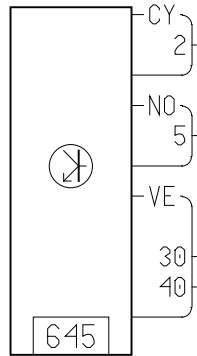

CY 2

NO 5

VE 30

40

645

13N-VE

CY 8

CY 8

R2

13A-VE

13N-GR

E13N-03

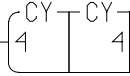

R2

13E-BA

MAM-NO

BPT-RG

BA 2  
3  
4

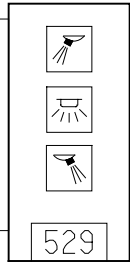

529

EMAM-A

MAM-NO



MAM

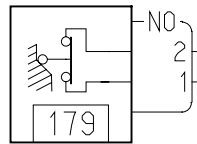

NO 2

1

179

MG-NO

13N-GR

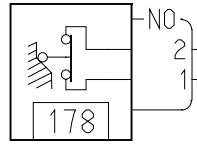

NO 2

1

178

MG-NO

13N-GR

MG-NO

13A-SA

NO 2  
1

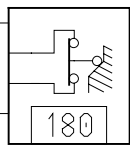

180

MG-NO

13A-SA

NO 2  
1

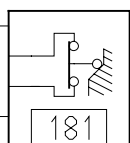

181

EMG-3

MG-NO

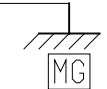

MG

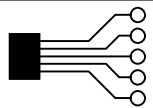

L90/SOP02

X90

04

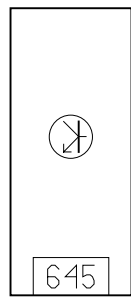

CY  
2

NO  
5

VE  
40

645

13E-BA

BPT-RG

13A-VE

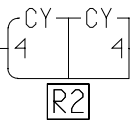

CY  
4

CY  
4

R2

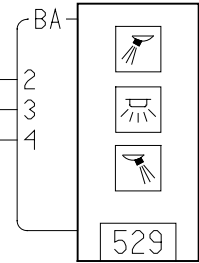

BA  
2  
3  
4

529

MAM-NO



MAM-NO



MAM

MG-NO

13A-SA

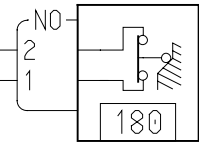

NO  
2  
1

180

MG-NO

13A-SA

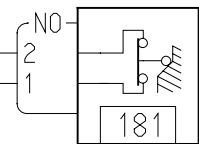

NO  
2  
1

181



MG-NO



MG

3-34

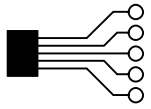

L90/SOP01

X90

04

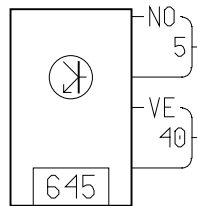

13A-VE

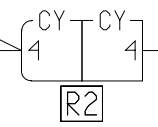

13A-OR

MAM-NO

BPT-RG

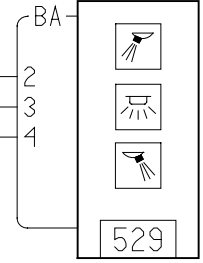

EMAM-A

MAM-NO



MAM

MG-NO

13A-SA

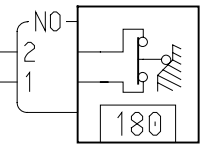

EMG-3

MG-NO



MG

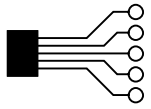

L90/E2

X90

04

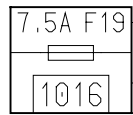

NO  
S19

LPD—BE



R2



MAN—NO

EMAN-A

LPD—BE

MAN—NO

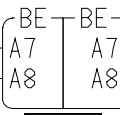

R292

LPD—BE

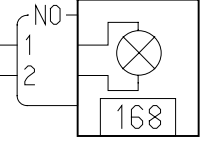

168

17A—BJ

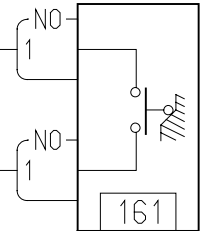

161



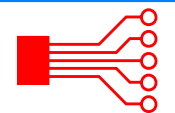

L90/ADAC/LAVPH

X90  
04

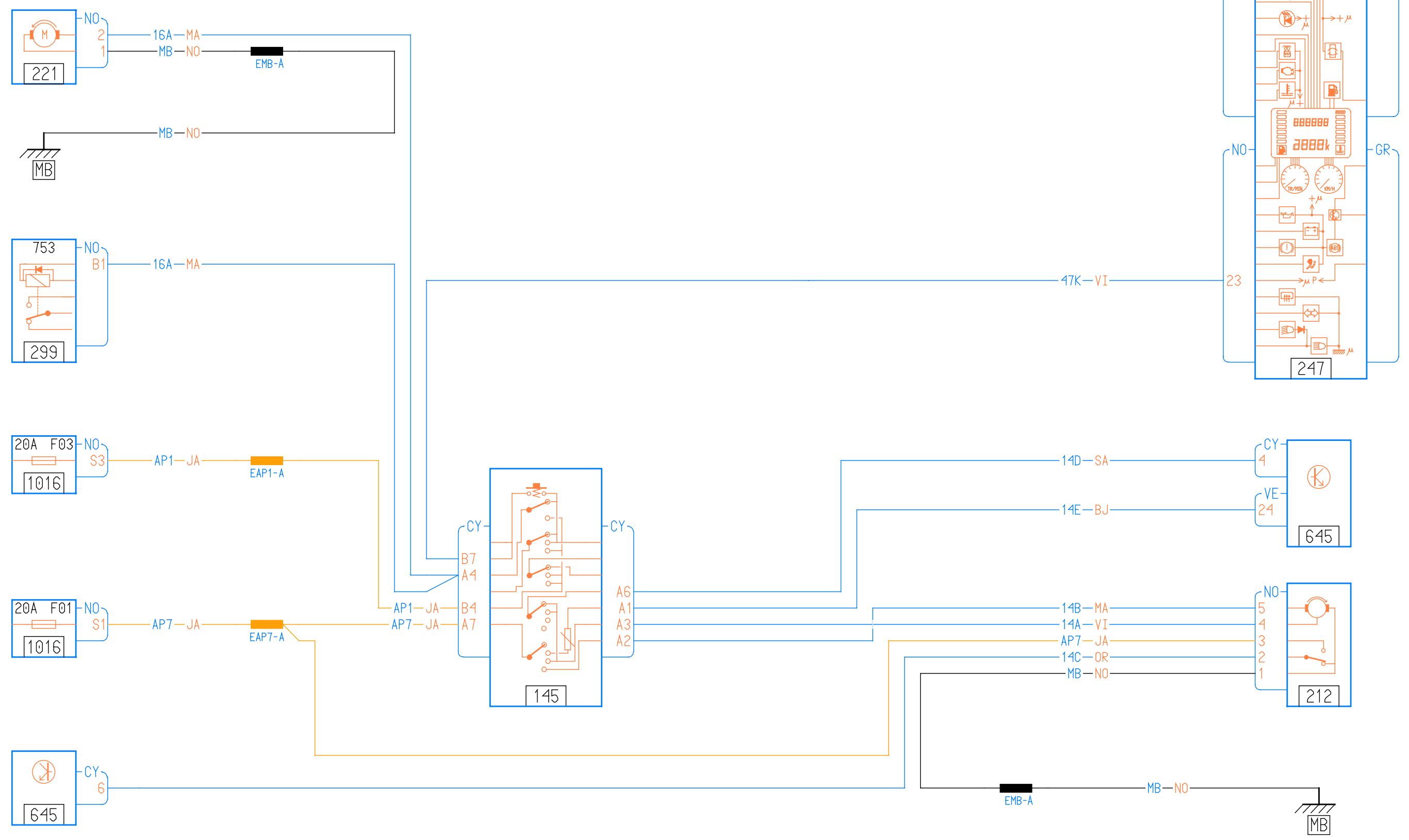

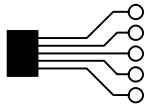

L90

X90

04

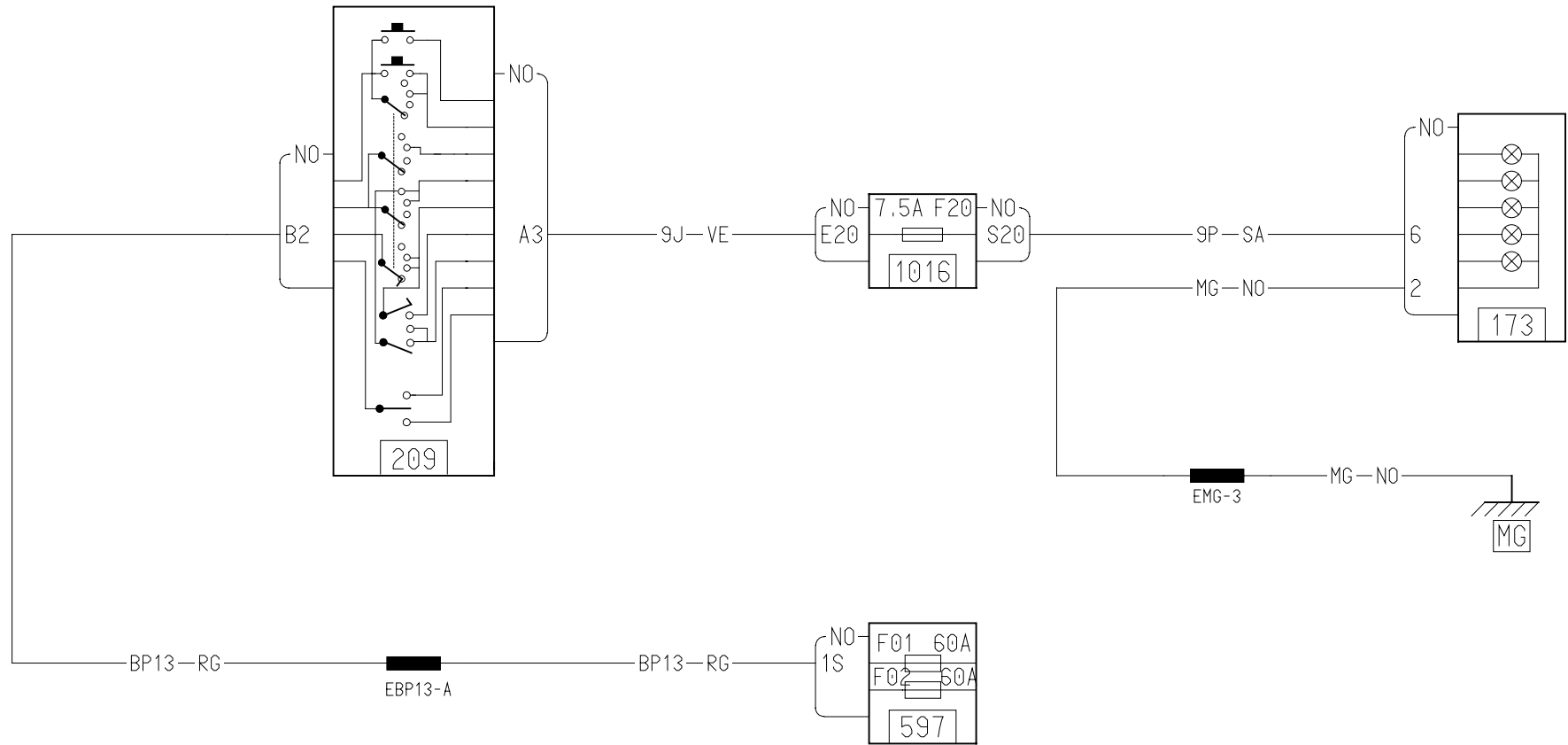

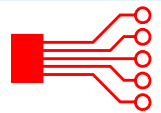

L90/PROJAB

X90  
04

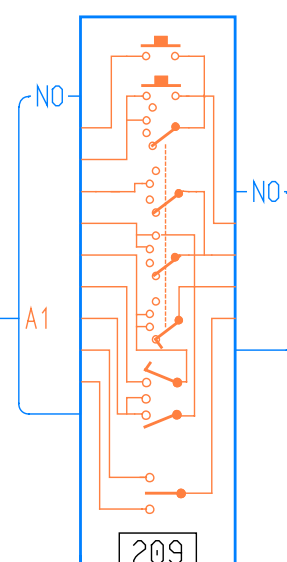
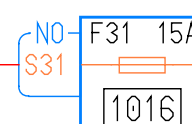
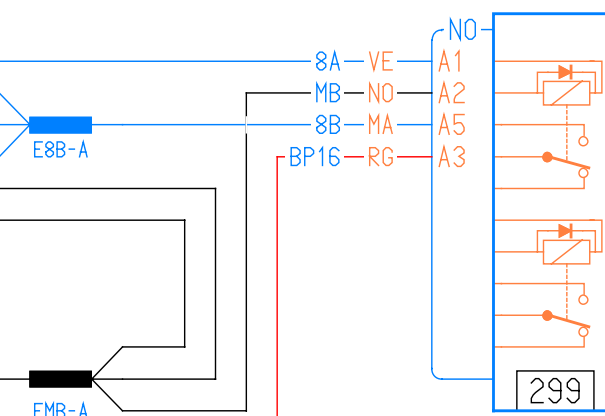
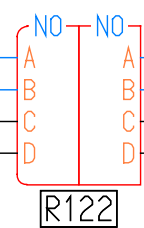
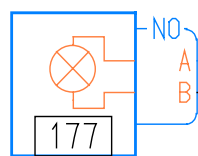
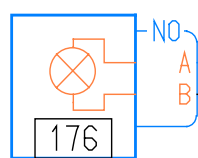
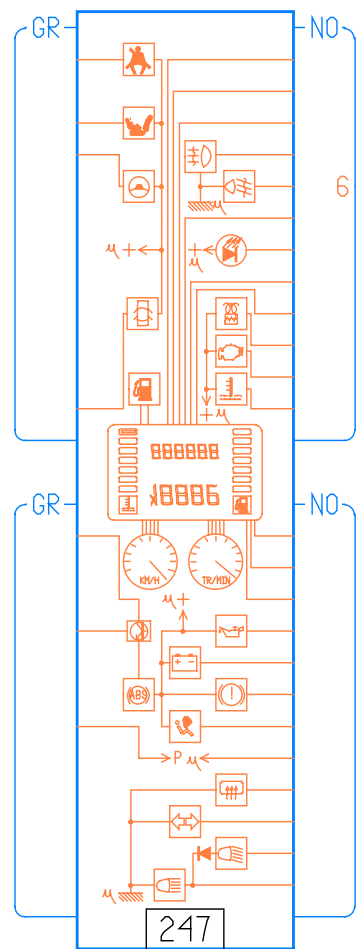

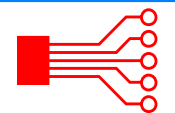

L90

X90  
04

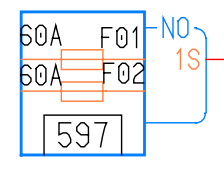

BP13-RG

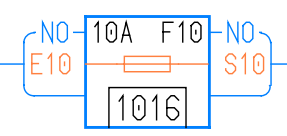
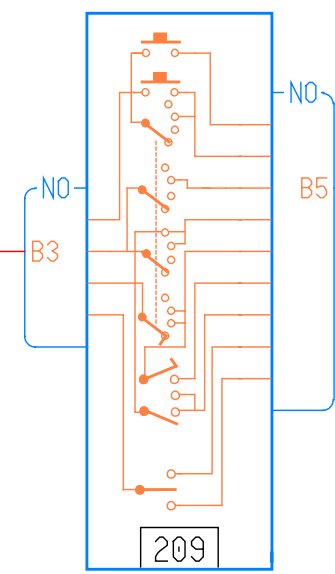

CPD-VI

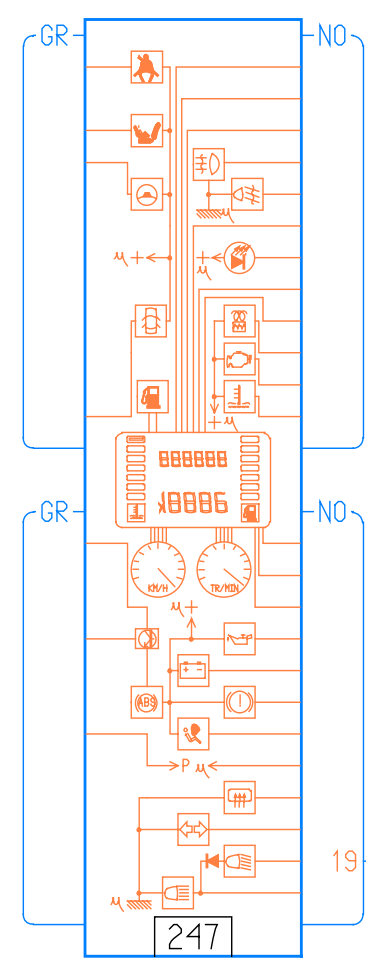
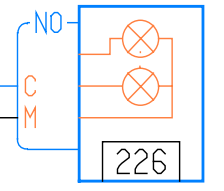

CPG-OR

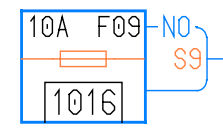

CPG-BA

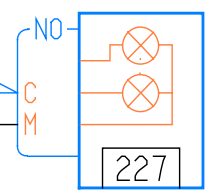

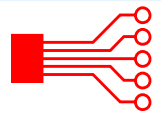

L90/LAVPH

X90  
04

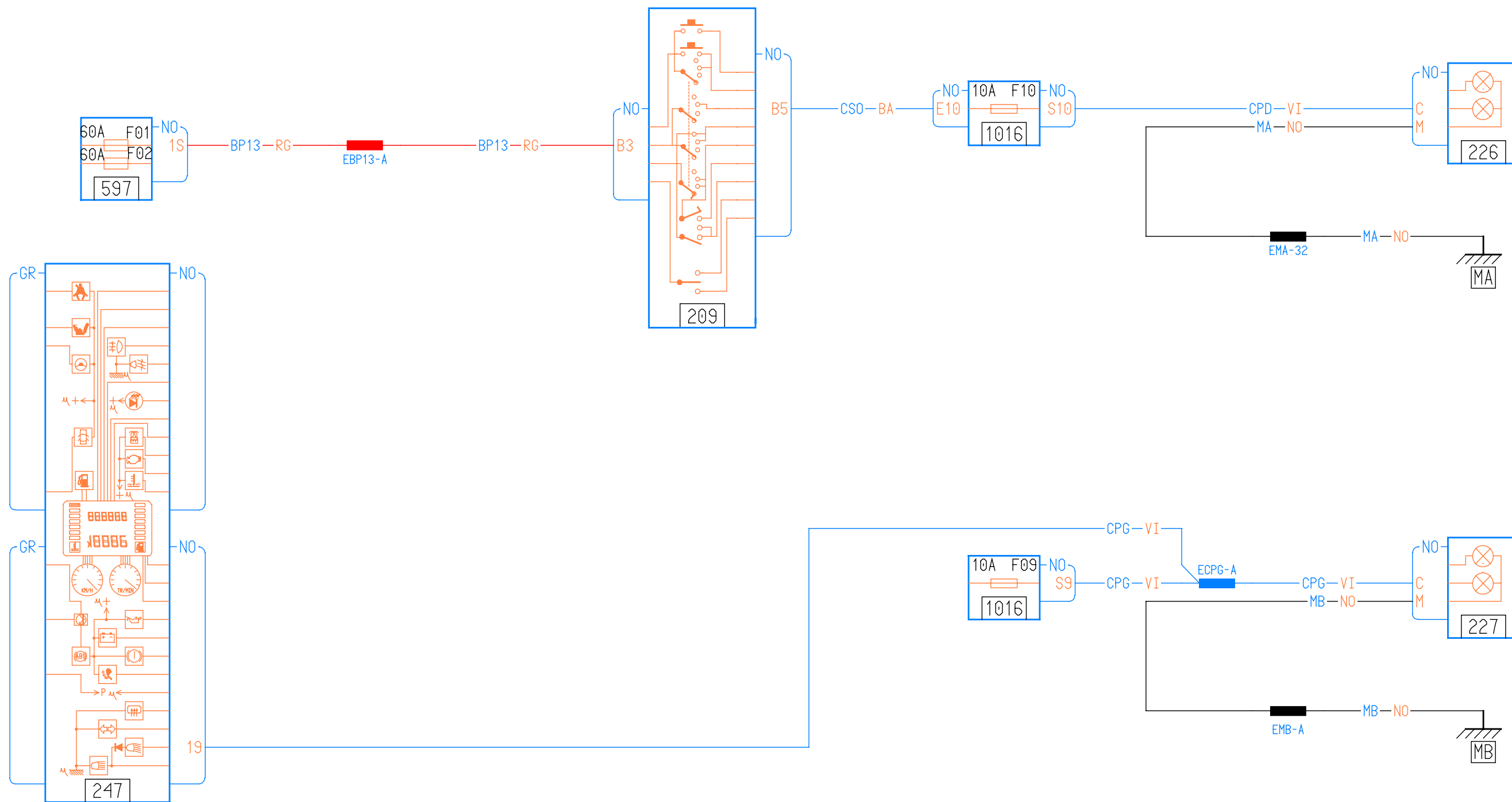

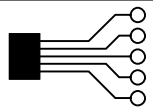

L90

X90  
04

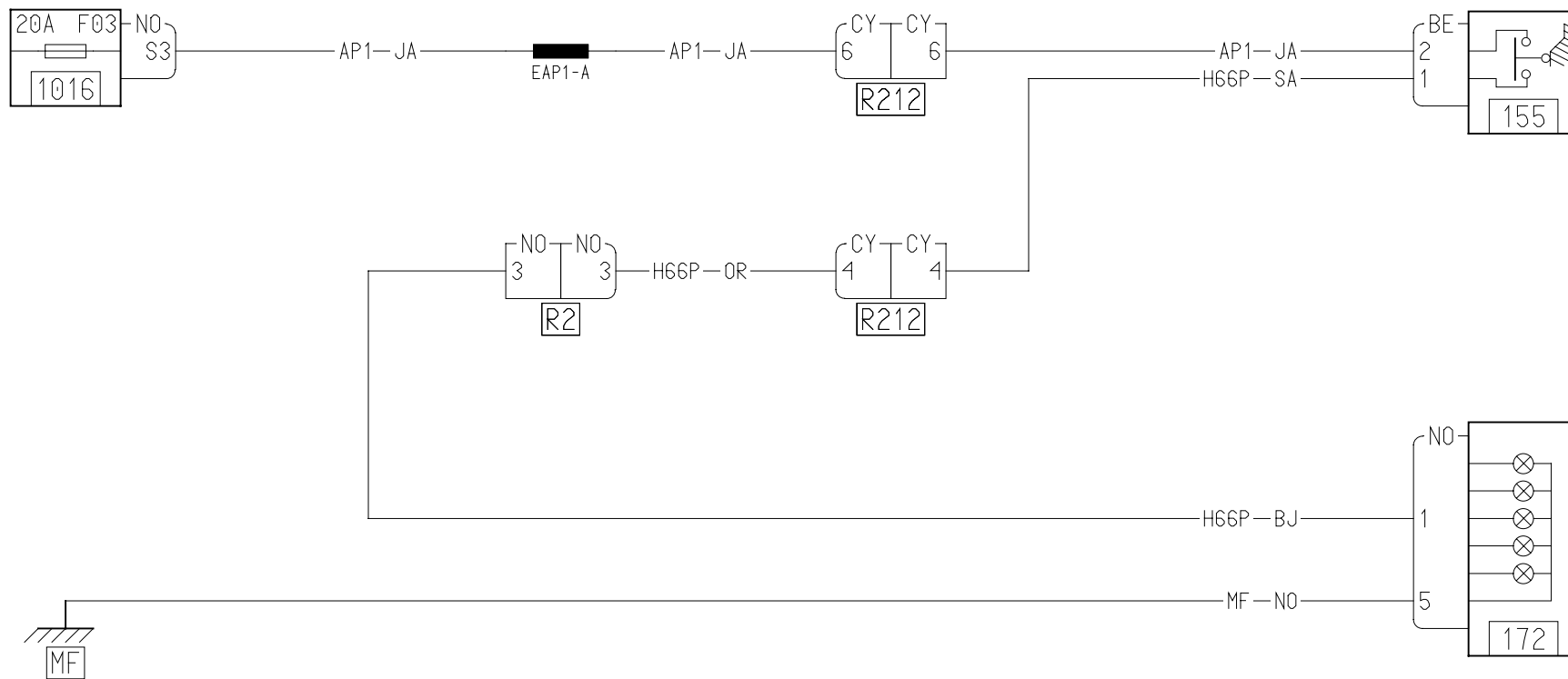

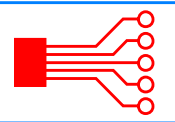

L90

X90  
04

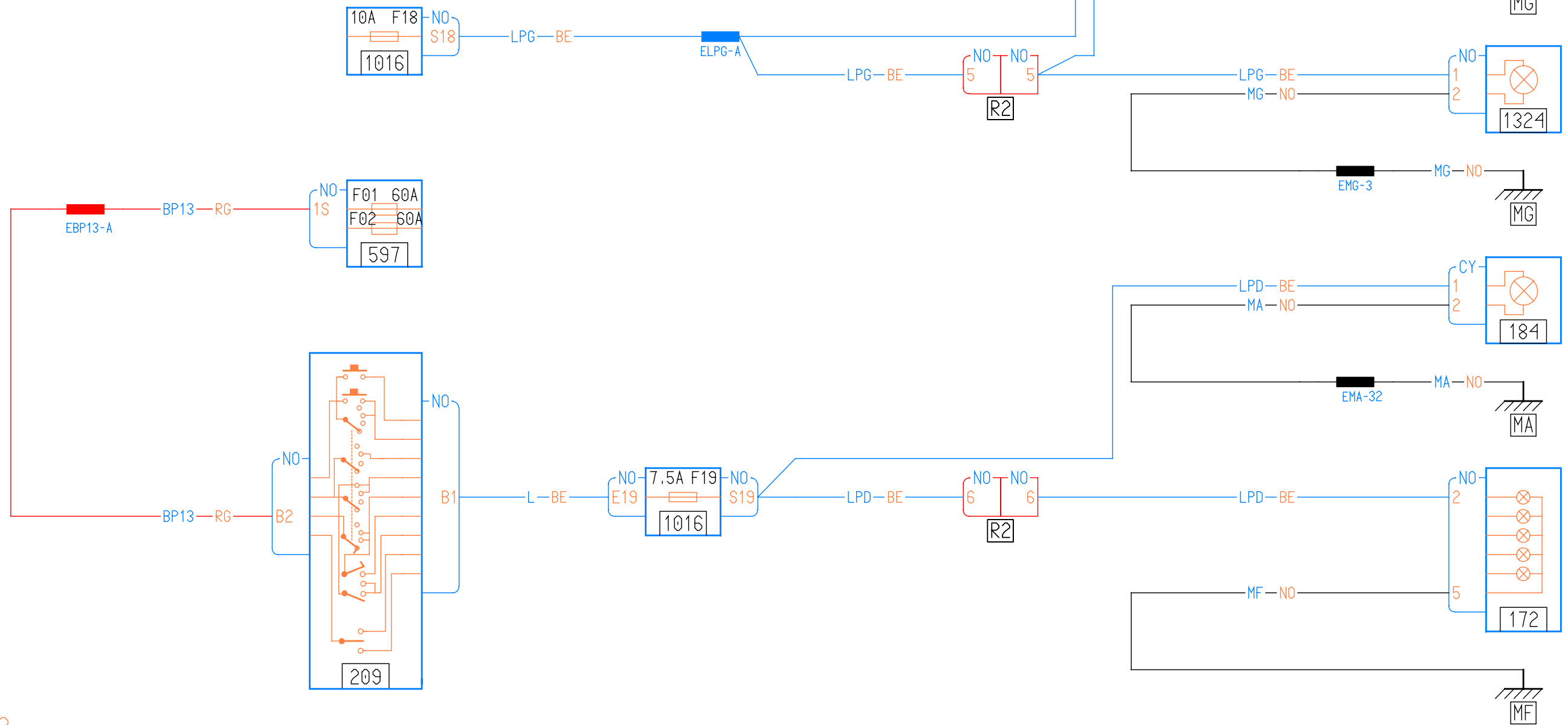

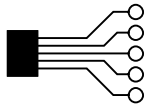

L90

X90

04

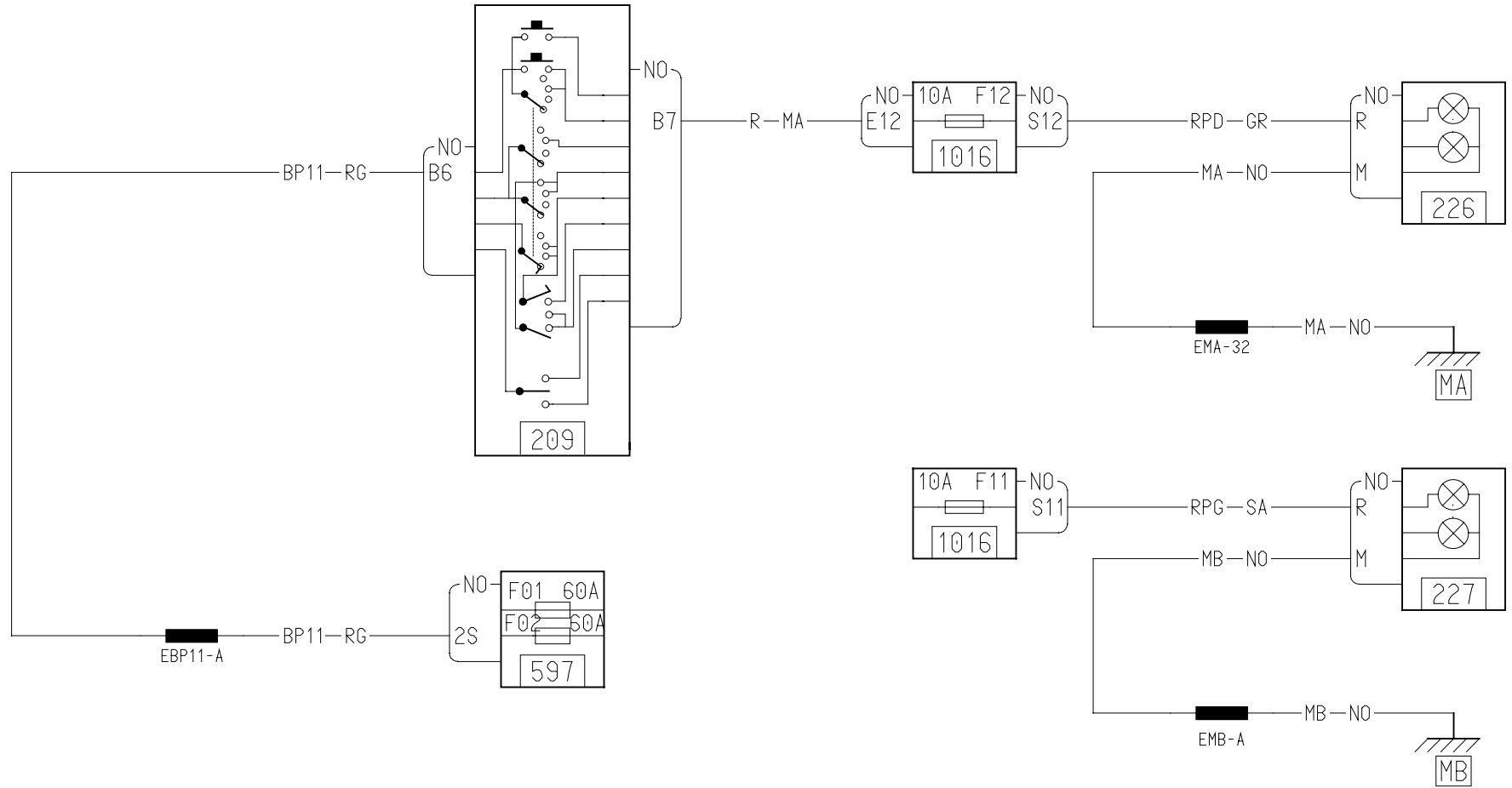



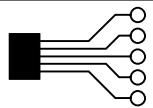

L90/ABS

X90

04

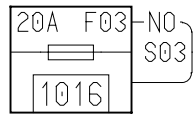

AP1-JA — EAP1-A

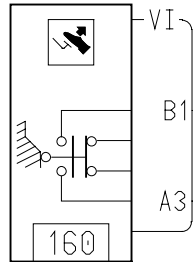

AP1-JA

65A-OR  
65A-GR

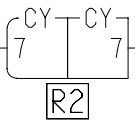

65A-OR

E65A-3

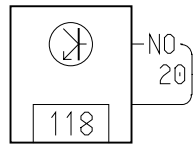

NO  
20

65A-OR

MG-NO

EMG-3

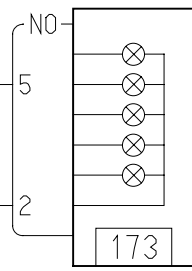

65A-OR

MG-NO

EMG-3

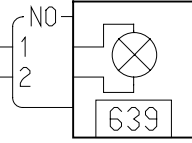

65A-OR

MF-NO

MF

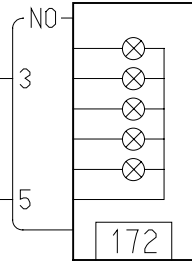

3-45

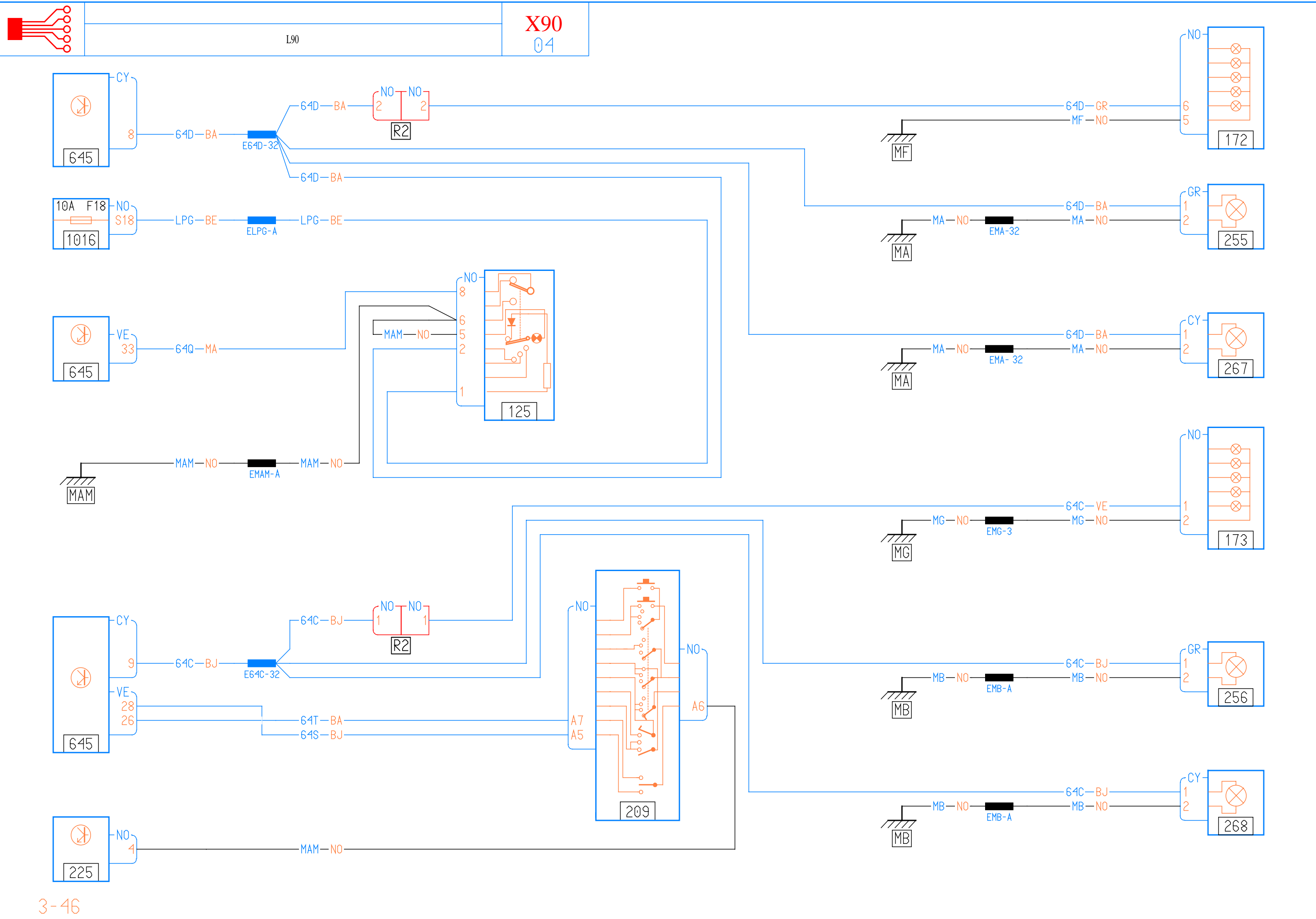

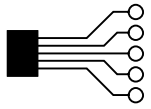

L90/ESS

X90

04

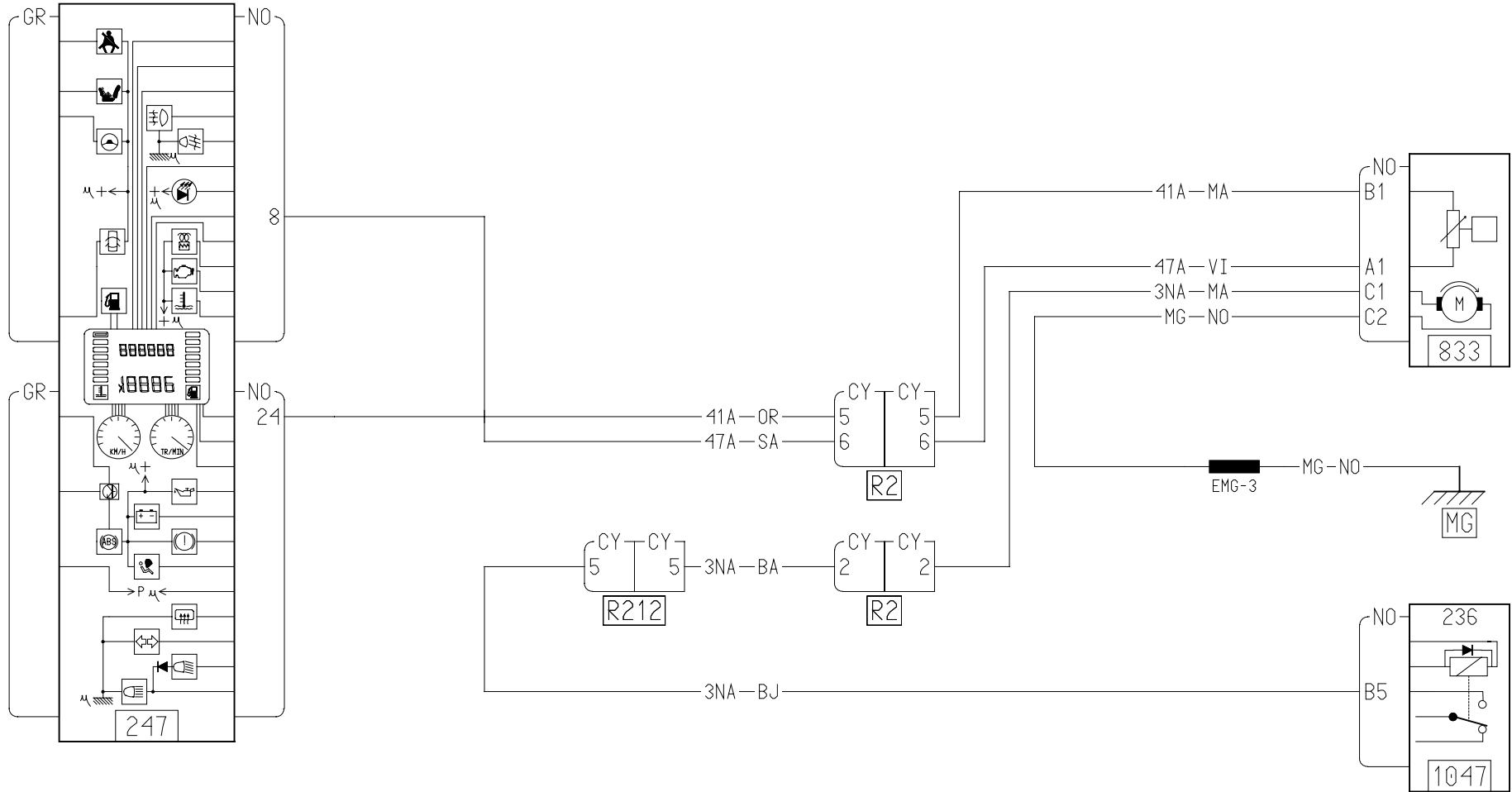

3-47

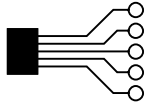

L90

X90  
04

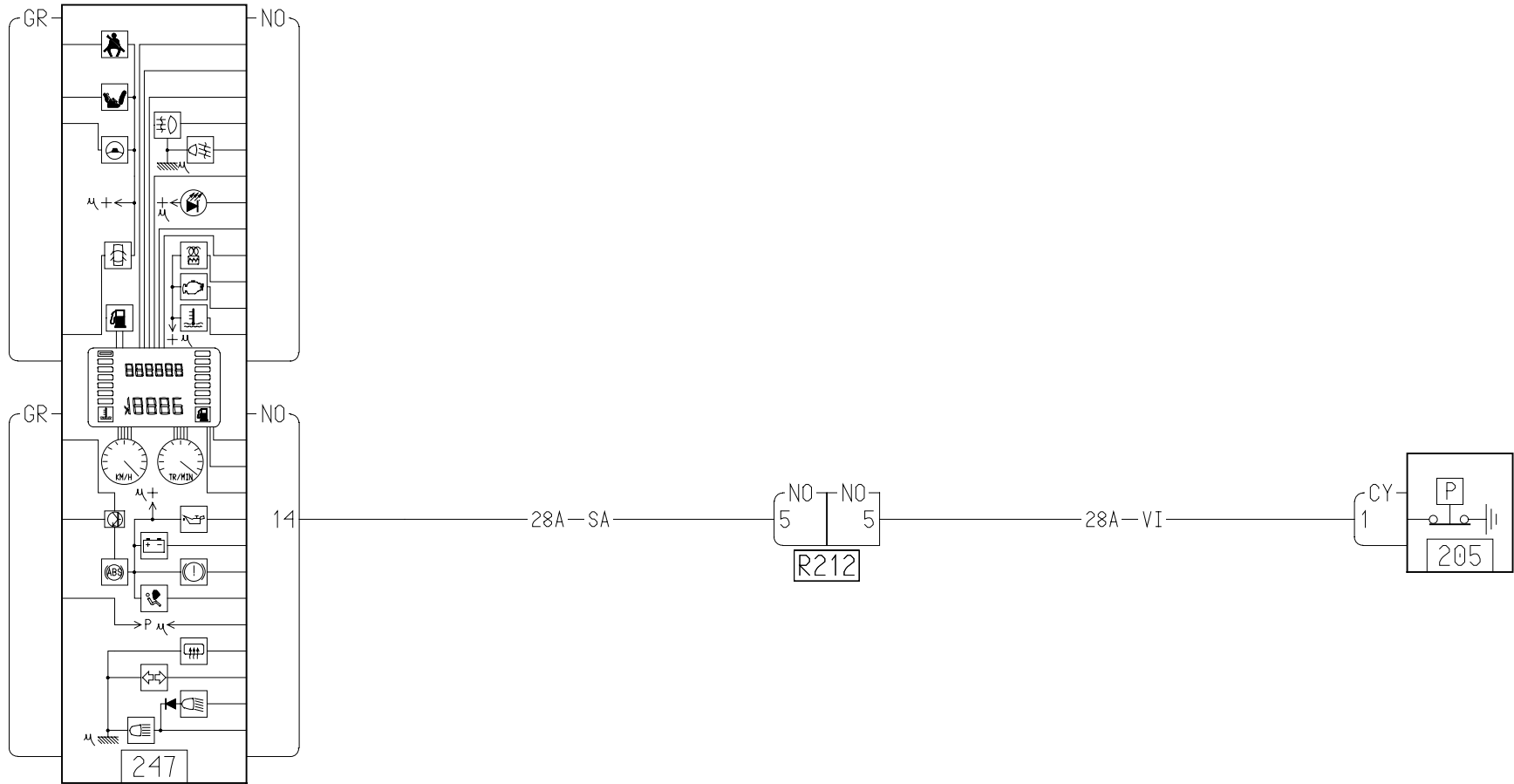





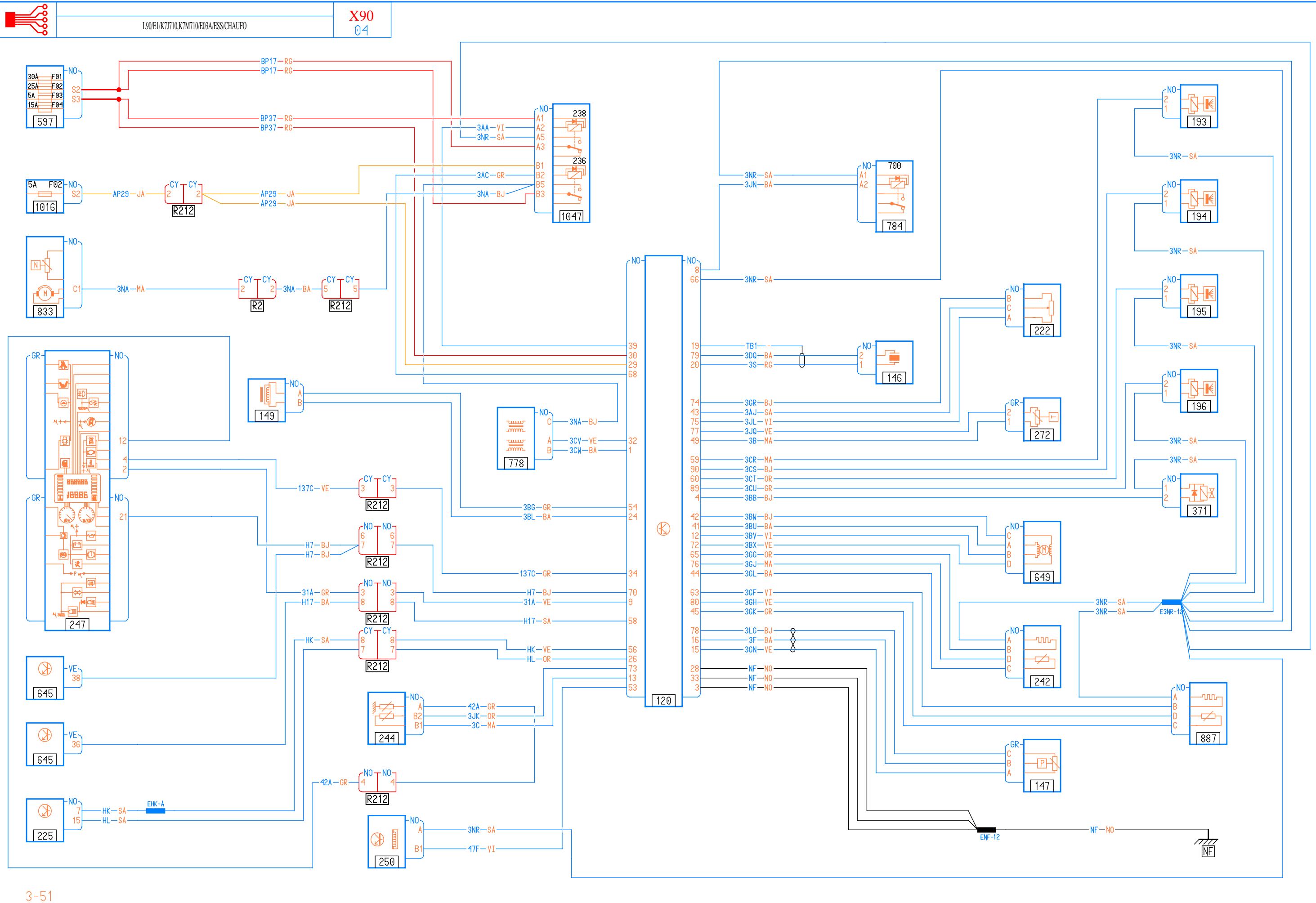

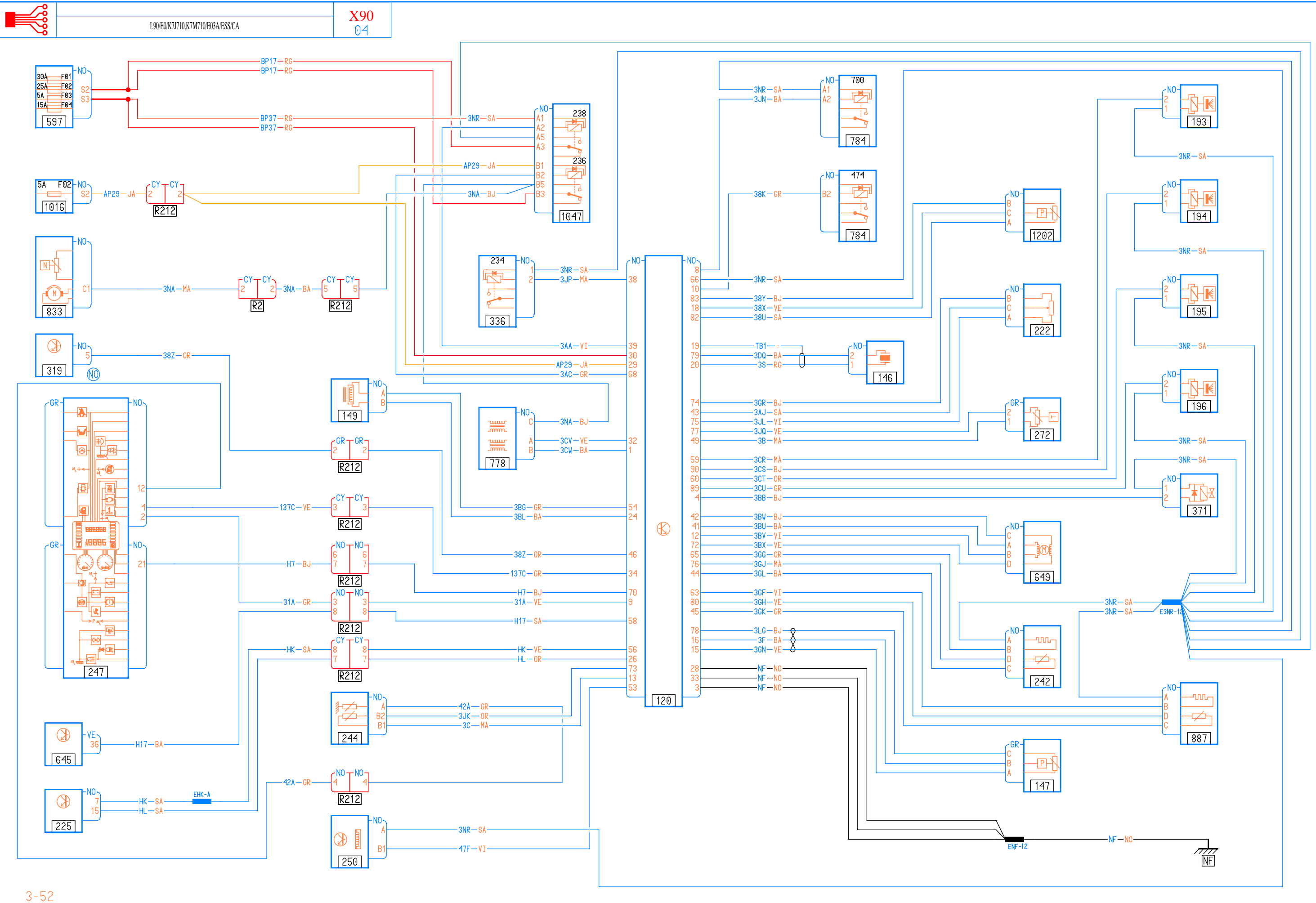



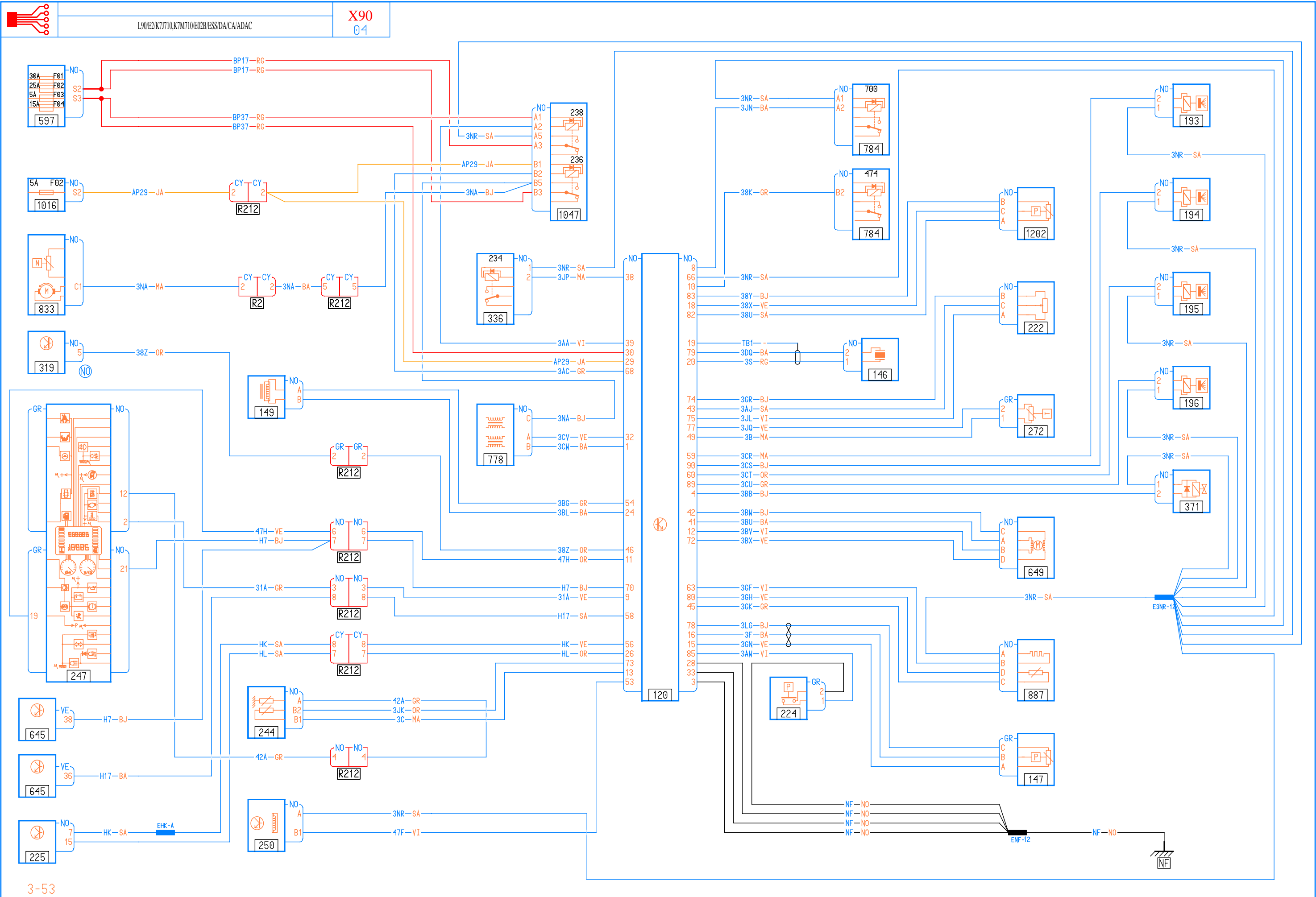

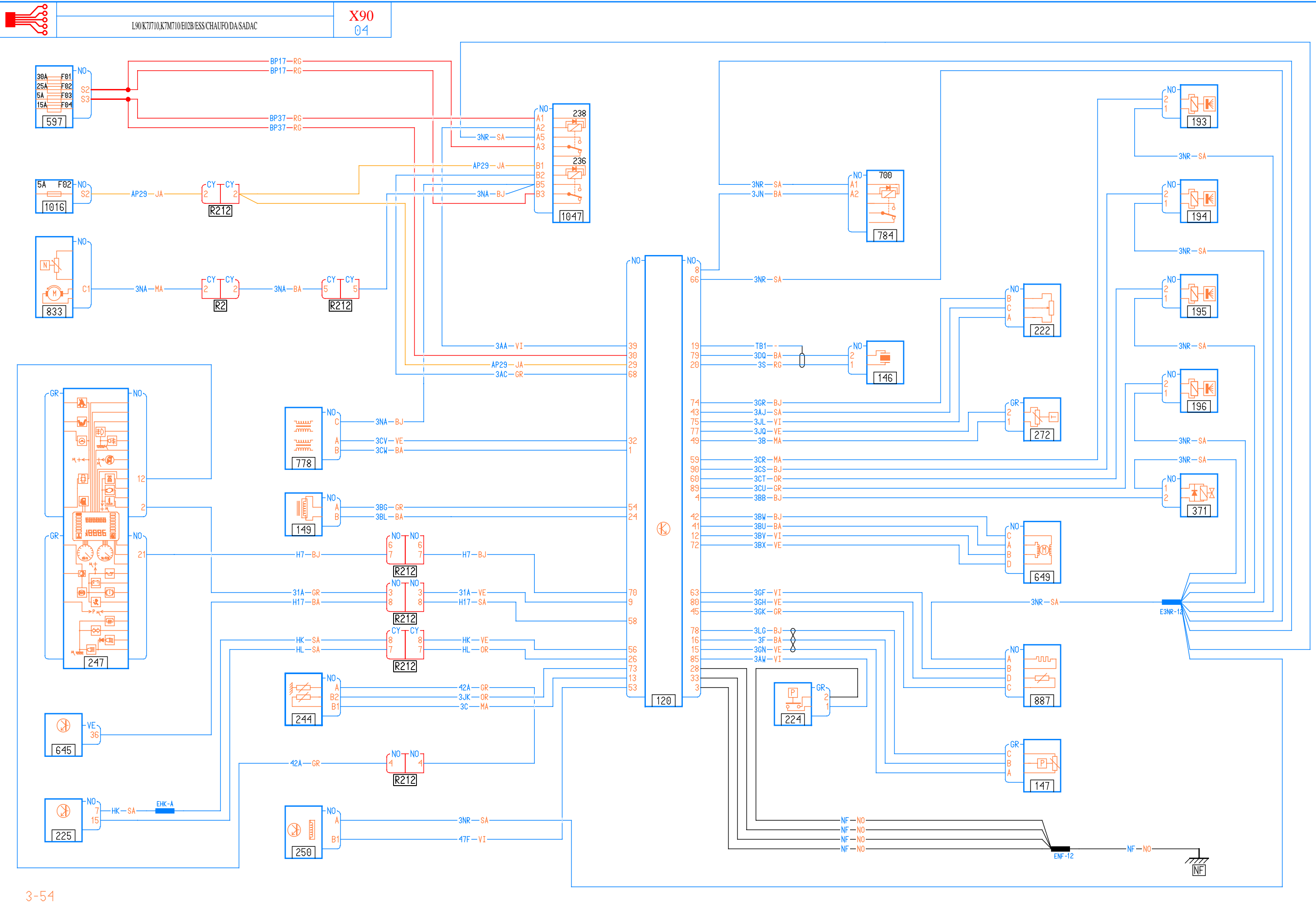

L90K7J710,K7M710/BJ2B/ESS/CHAUF/DA/SADAC

**X90**  
04

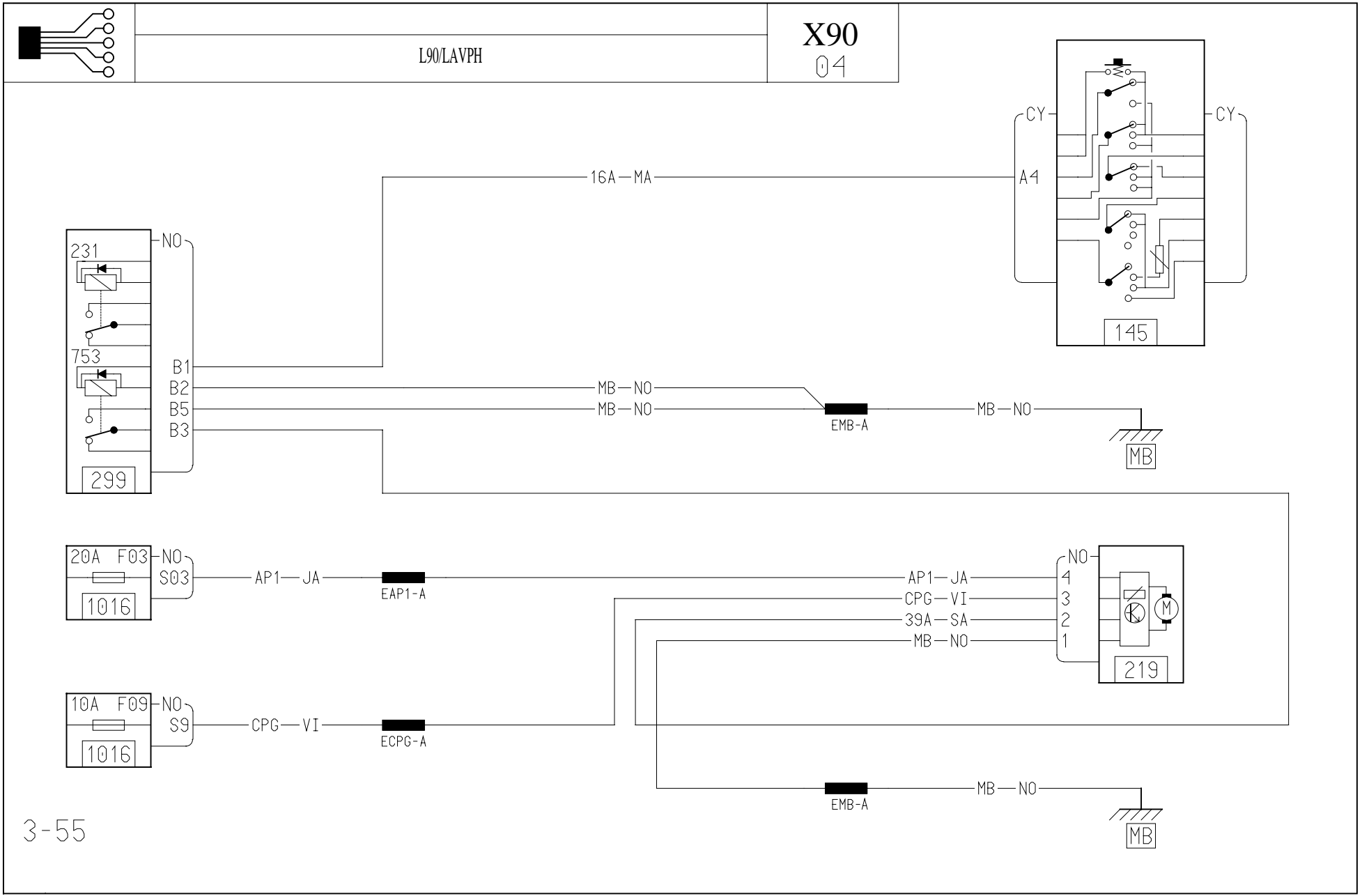

3-55

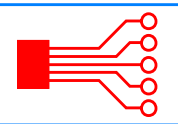

L90/LVAREL

X90  
04

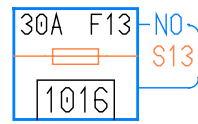

AP30-JA

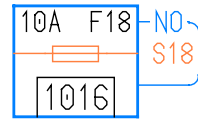

LPG-BE

ELPG-A

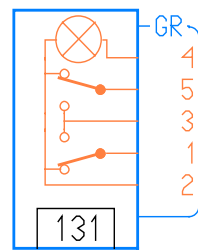

LPG-BE

23K-BJ

AP30-JA

23J-VE

23E-SA

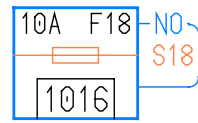

LPG-BE

ELPG-A

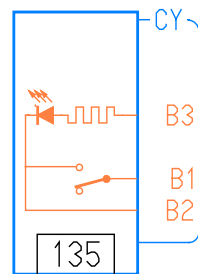

LPG-BE

MAN-NO



MAN-NO

EMAN-A

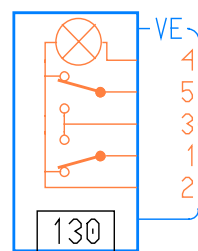

LPG-BE

23H-BJ

23G-VE

23E-SA

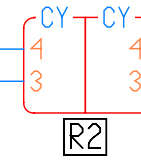

23K-BA

23J-BJ

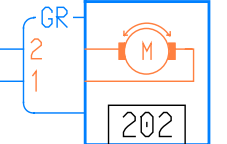

M

202

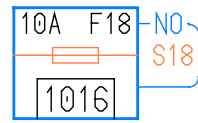

LPG-BE

ELPG-A

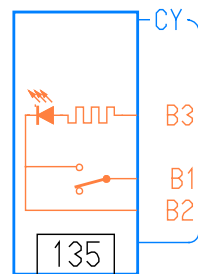

LPG-BE

MAN-NO



MAN-NO

EMAN-A

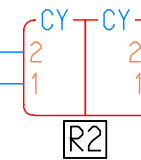

23H-VE

23G-MA

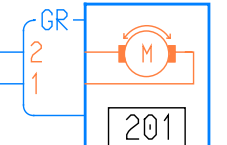

M

201

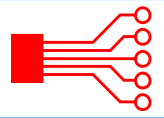

L90/LVCIPE

X90  
04

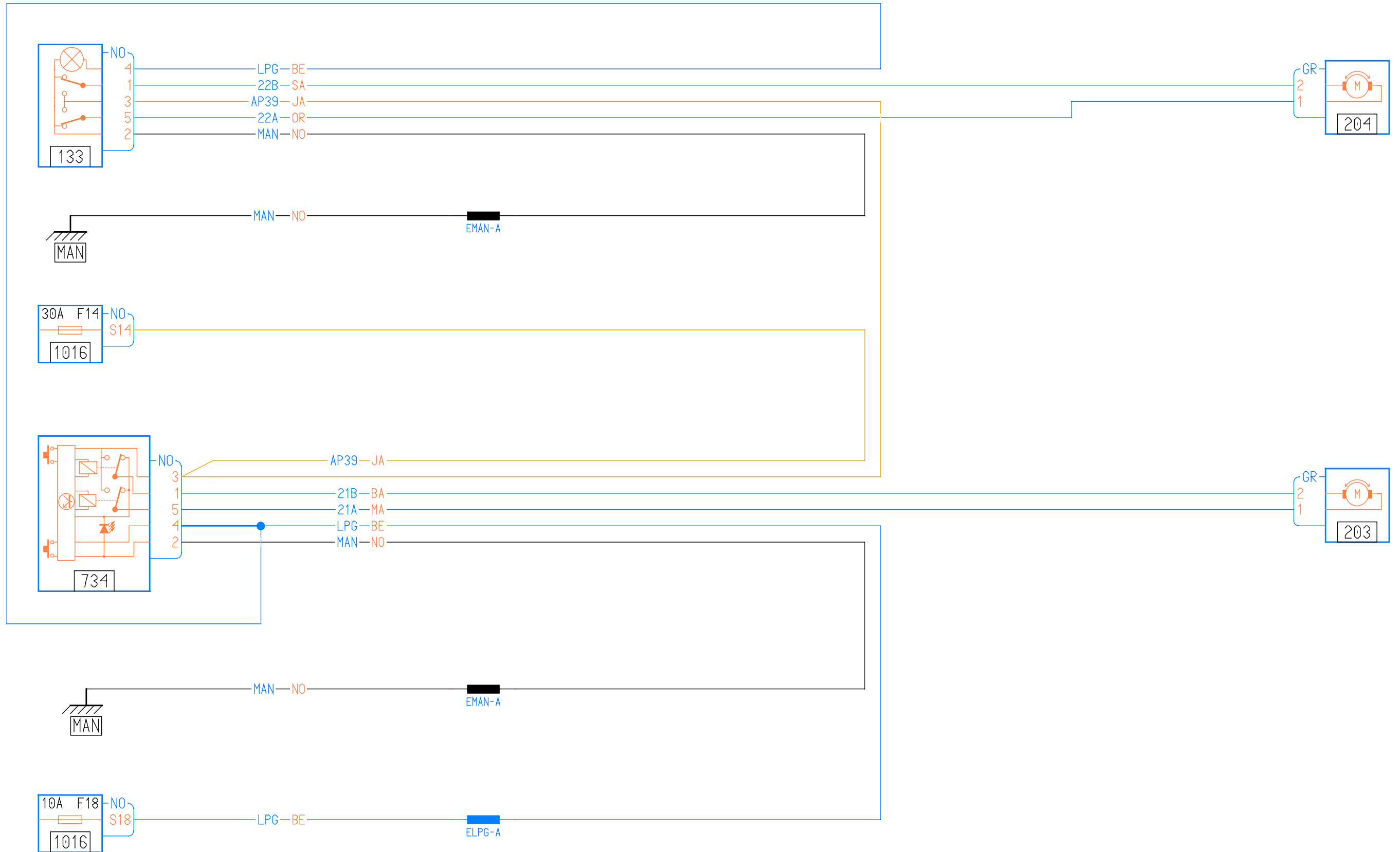

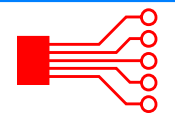

L90/LVAVEL

X90  
04

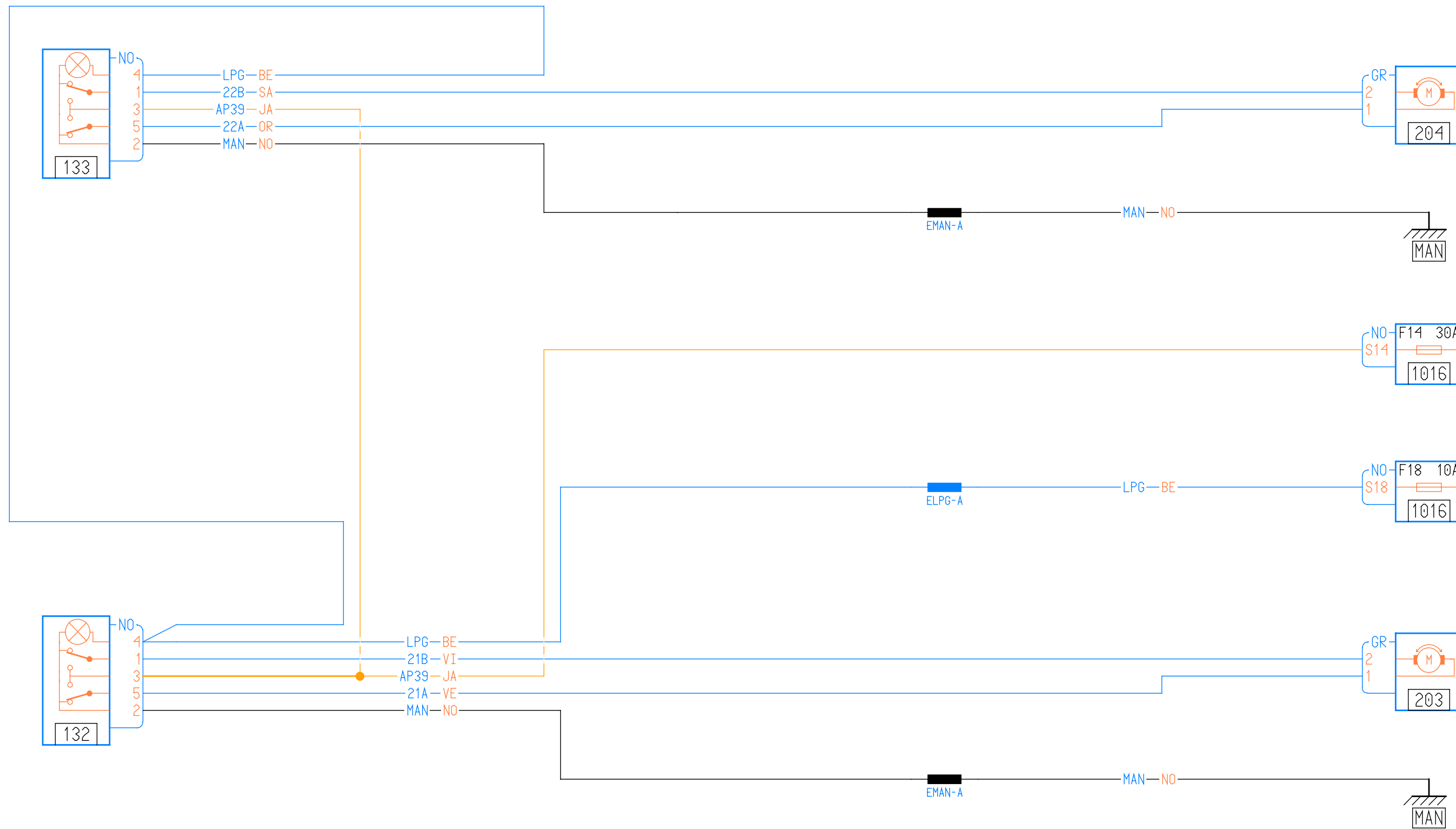

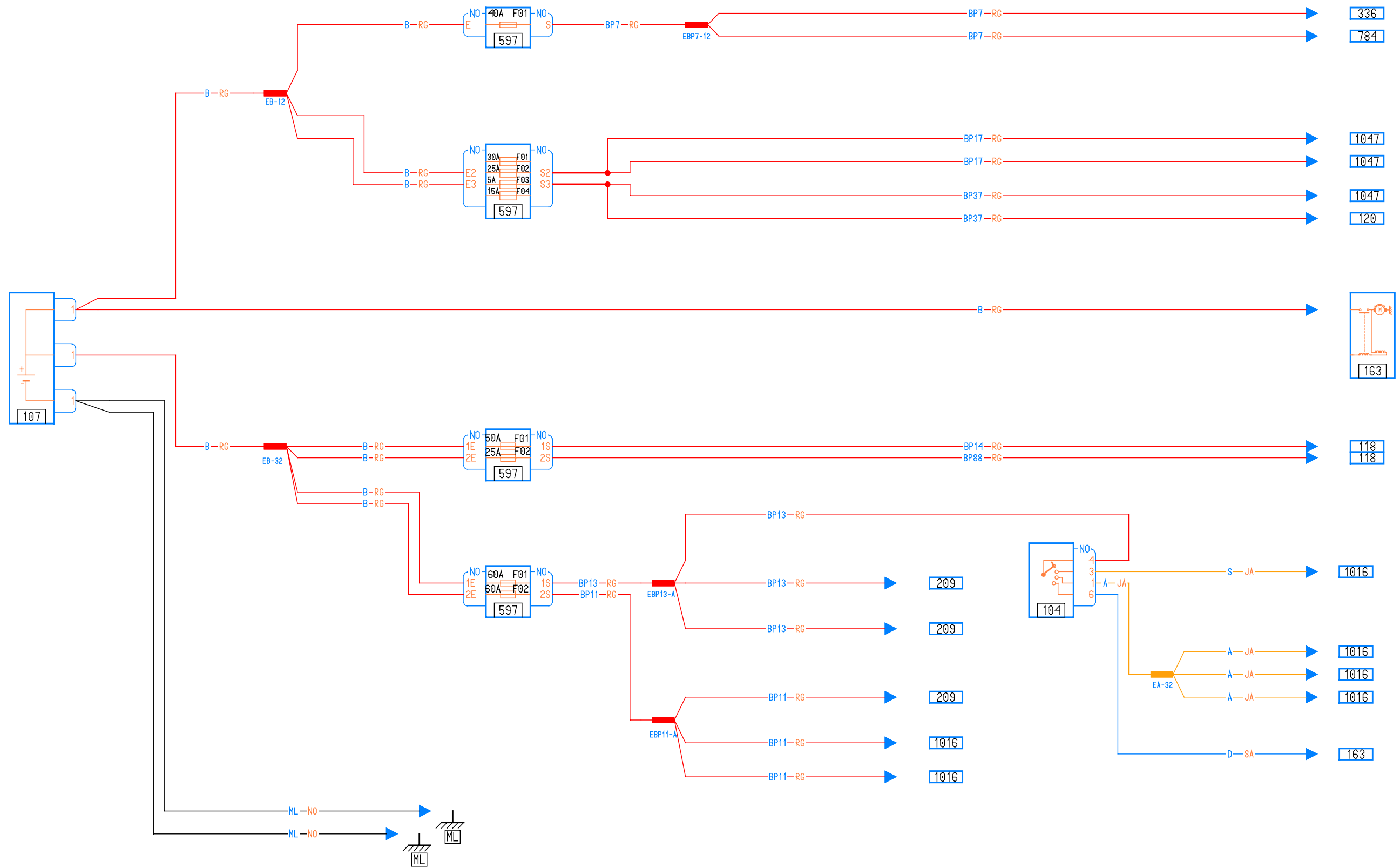
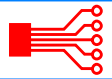

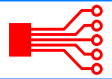

L90/GDFROLTEMPCHAUF0

X90  
04

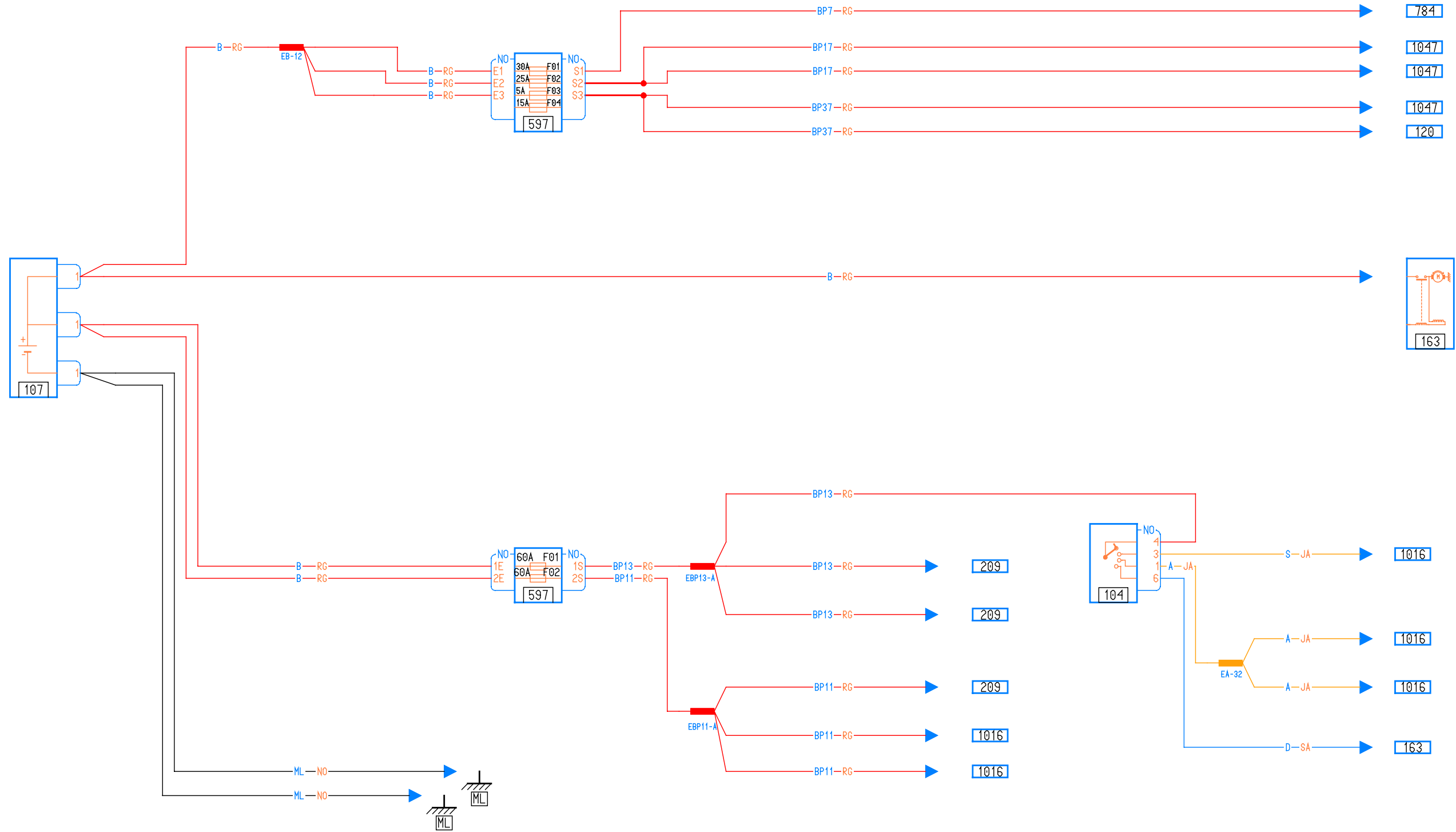



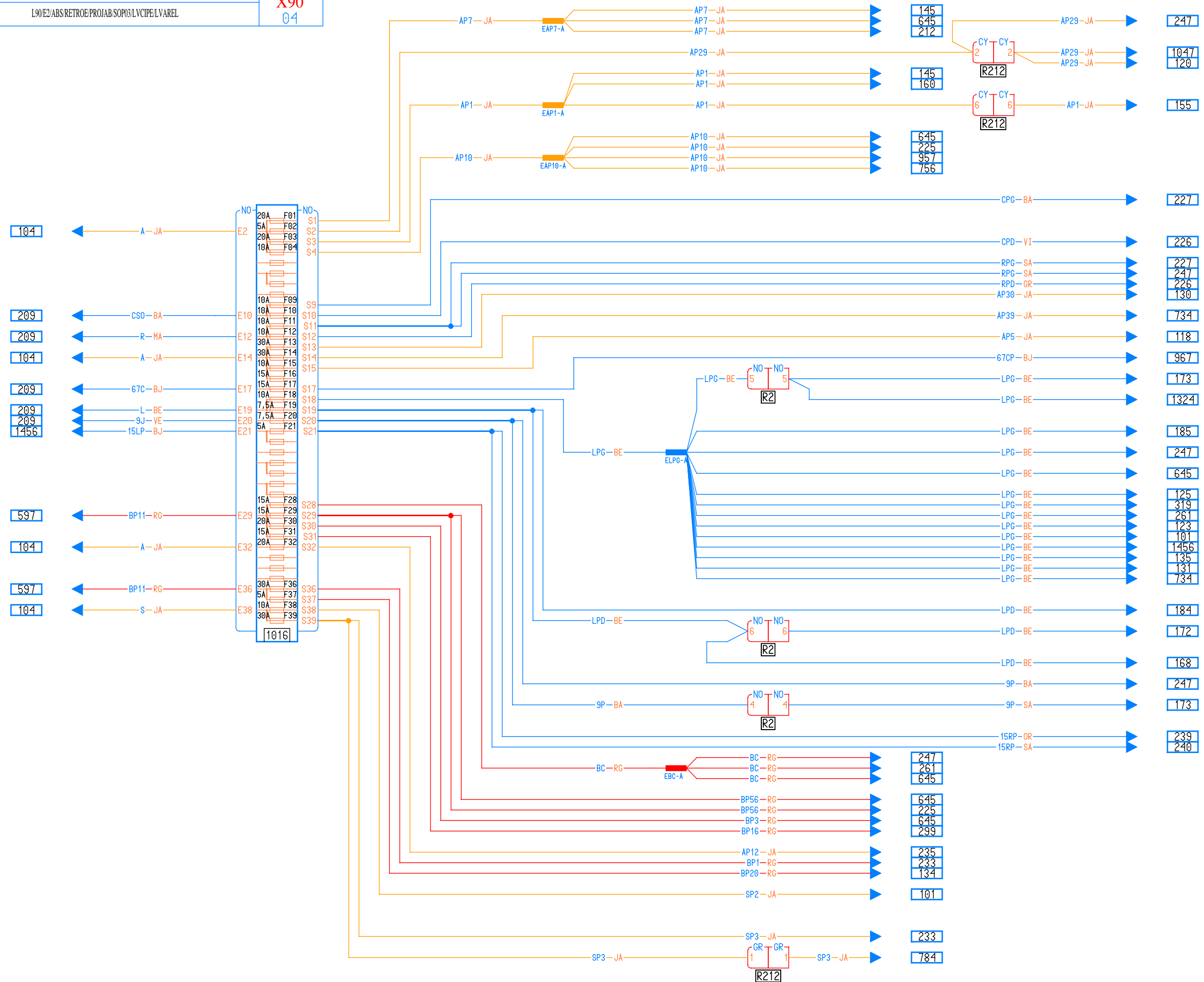
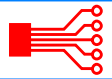

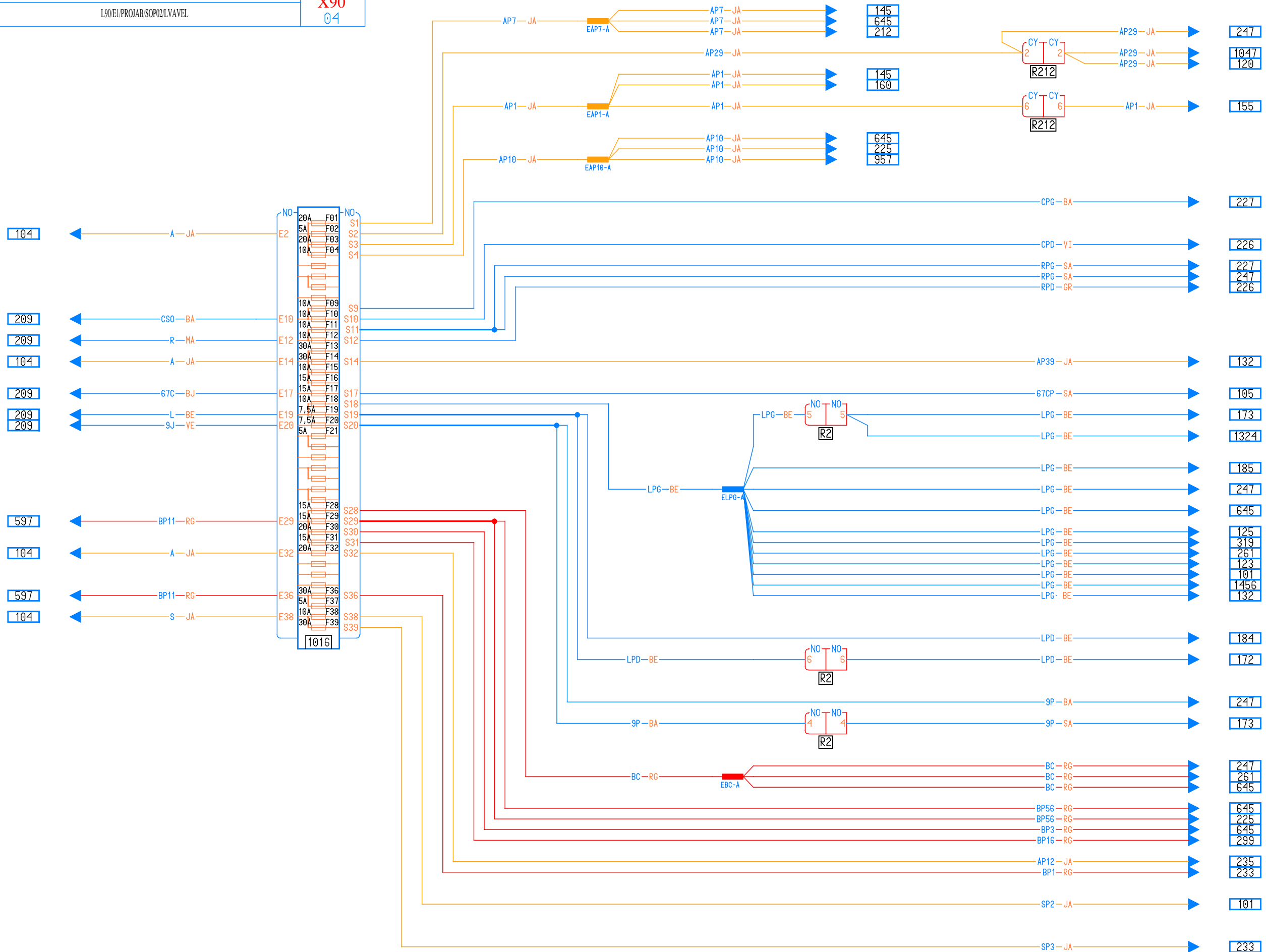
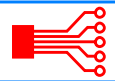

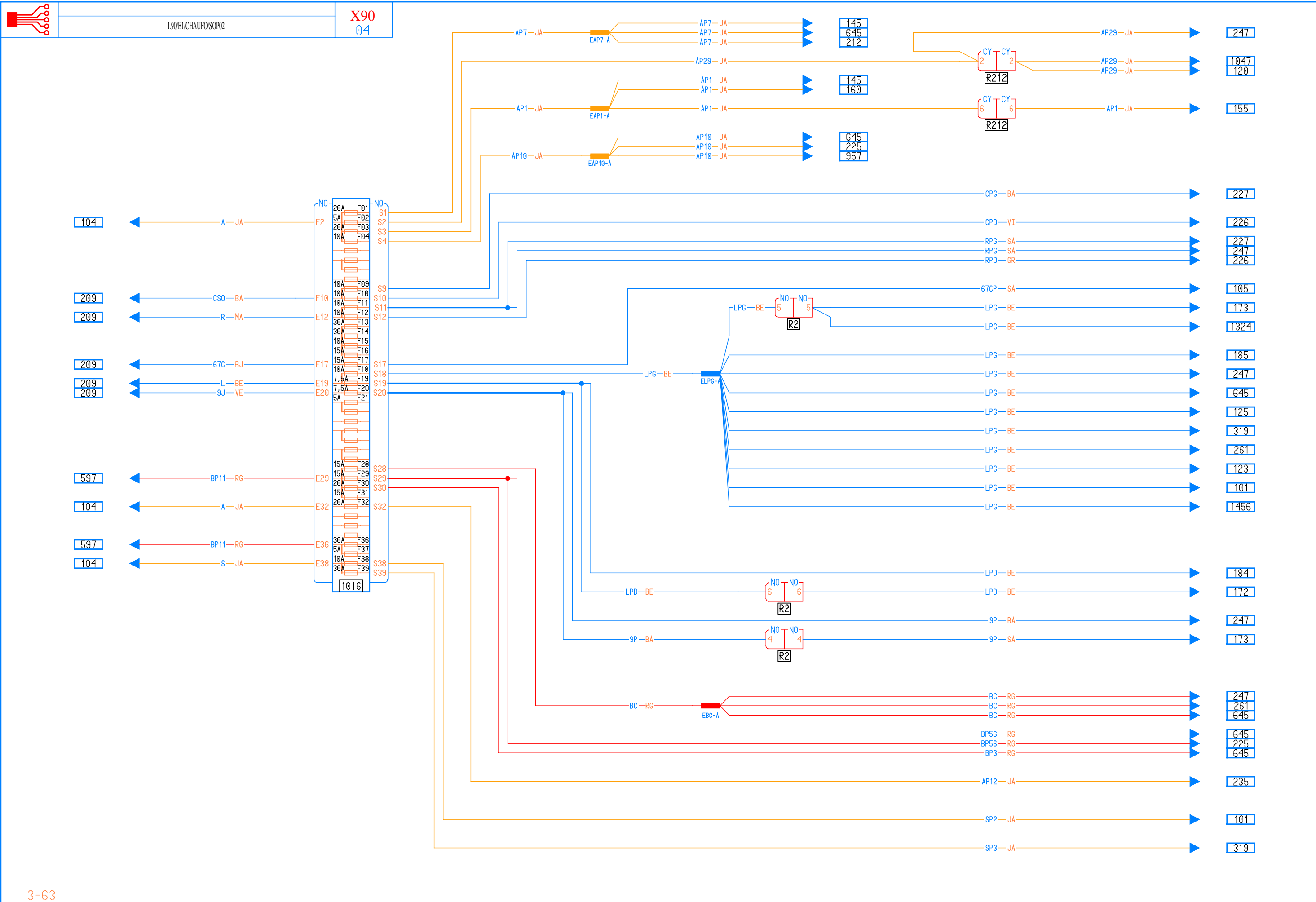

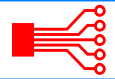

- 104 ← A-JA
- 209 ← CS0-BA
- 209 ← R-MA
- 104 ← A-JA
- 209 ← 67C-BJ
- 209 ← L-BE
- 209 ← 9J-VE
- 128 ← 15LP-BJ
- 1456
- 597 ← BP11-RG
- 104 ← A-JA
- 597 ← BP11-RG
- 104 ← S-JA

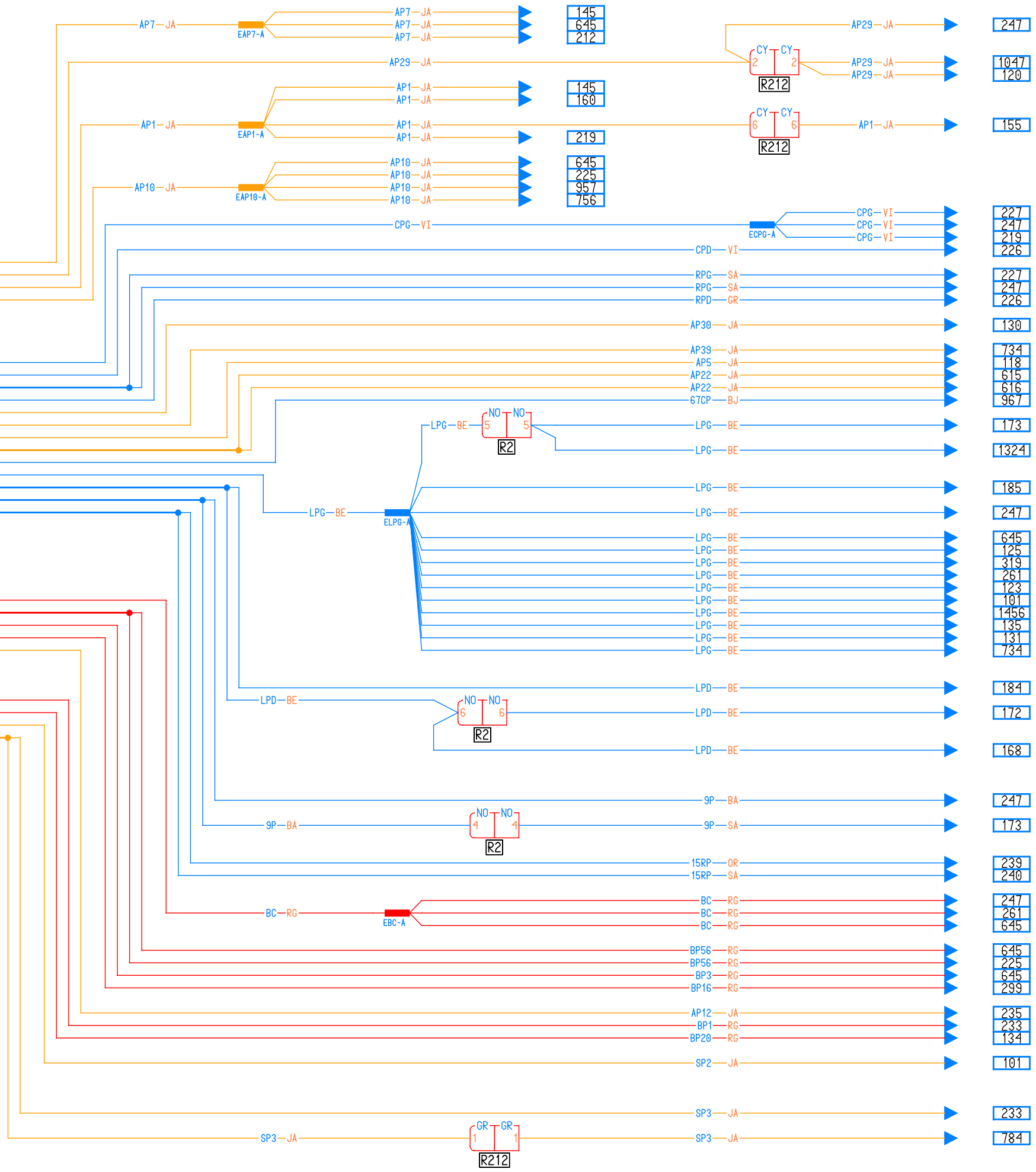
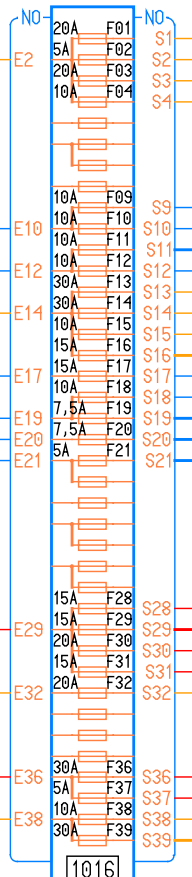

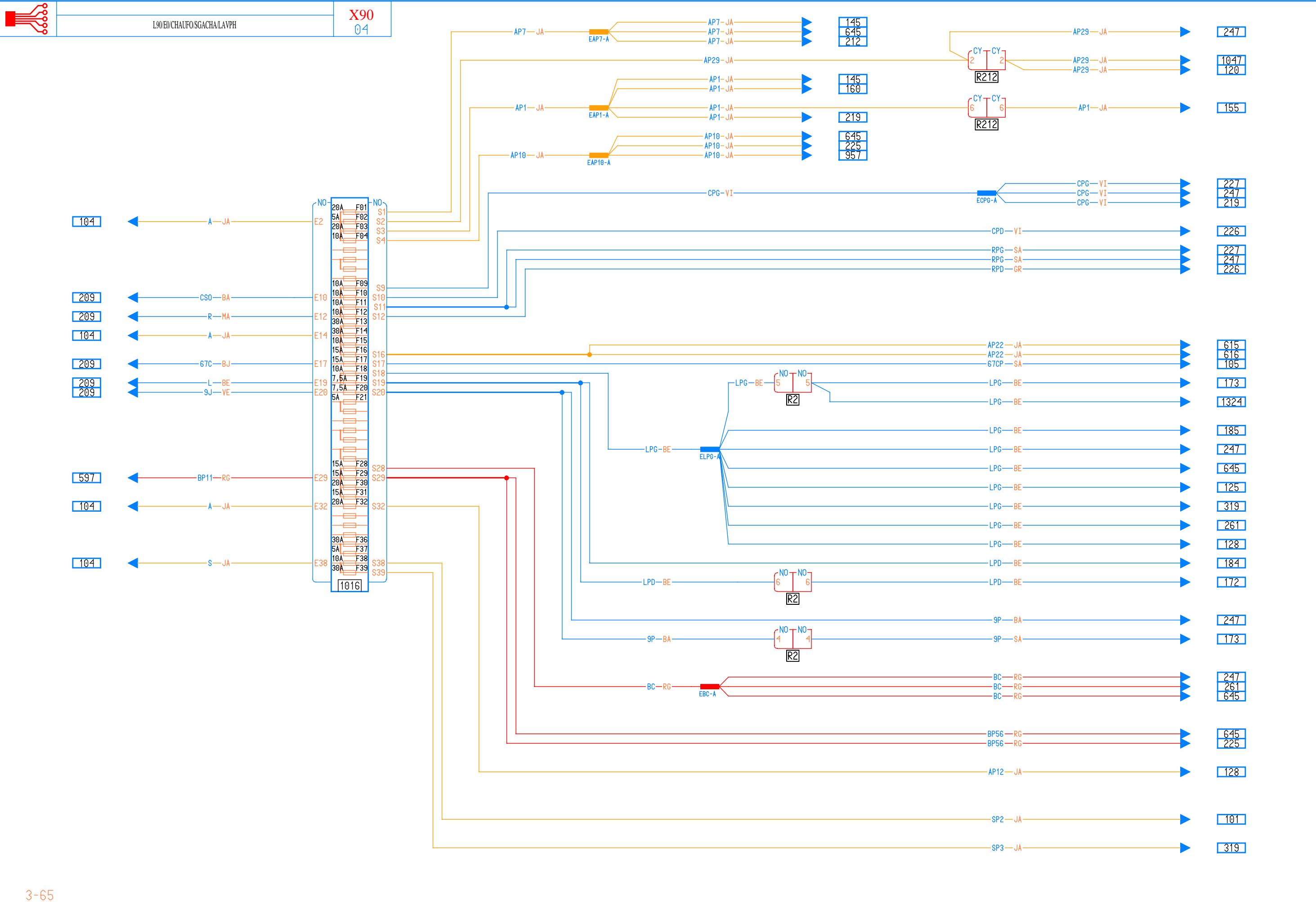

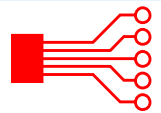

L90/ESS/ABS

X90  
04

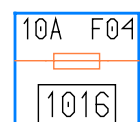
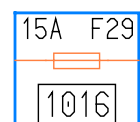

209

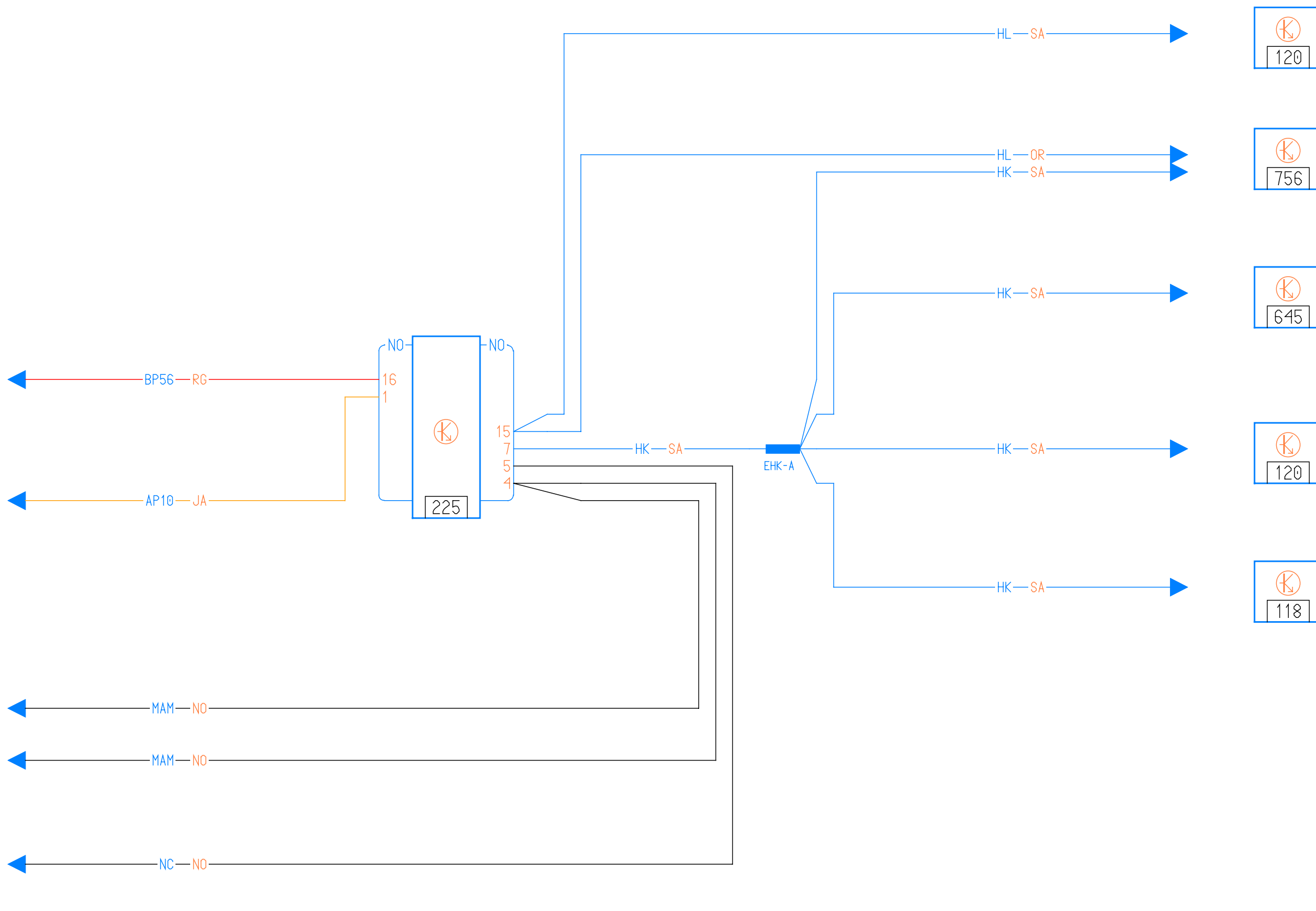
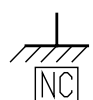

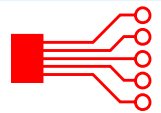

L90/ESS/ABCO01

X90  
04

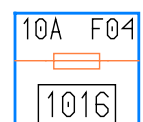
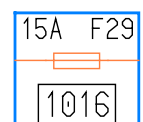

209

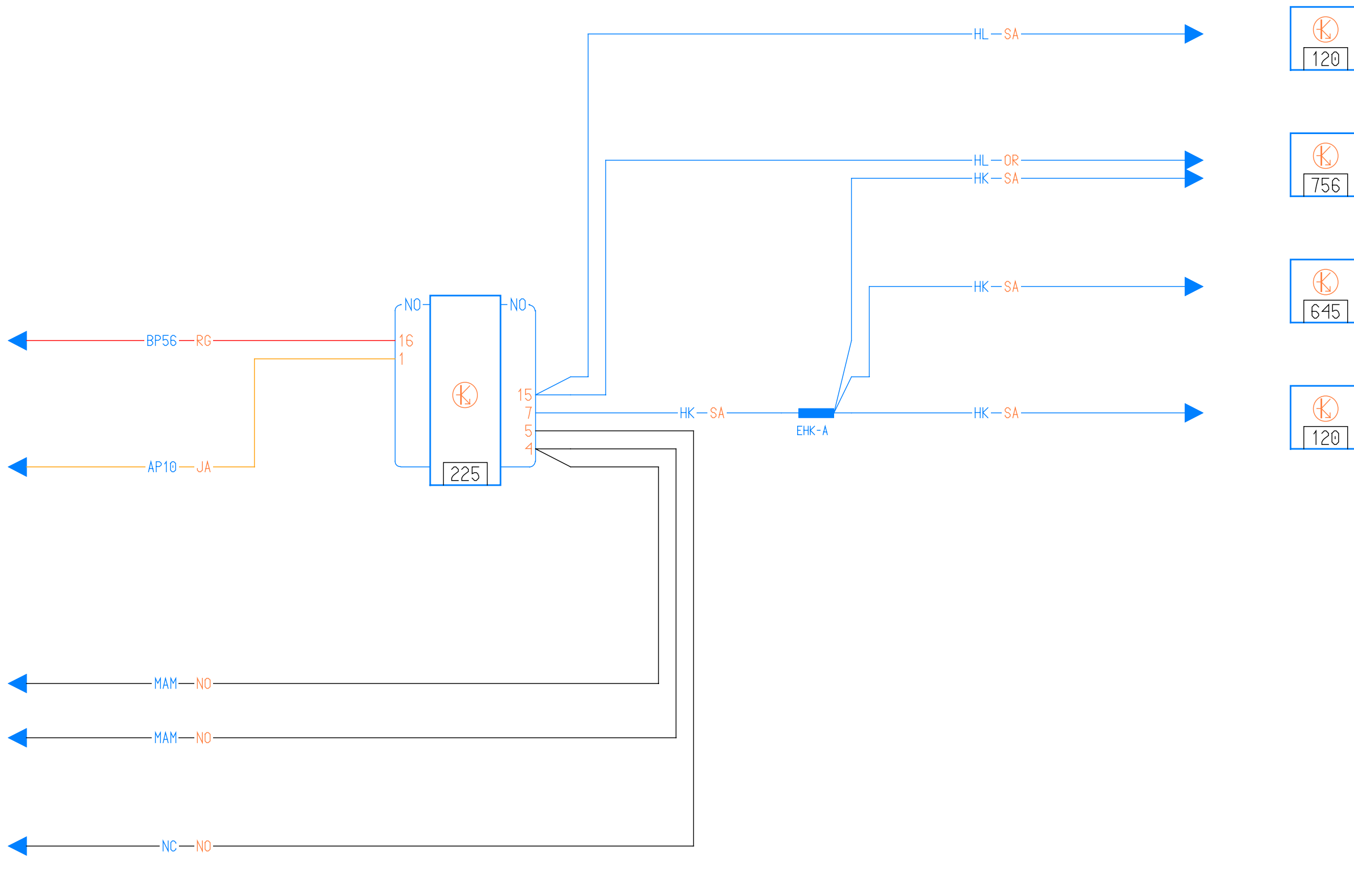

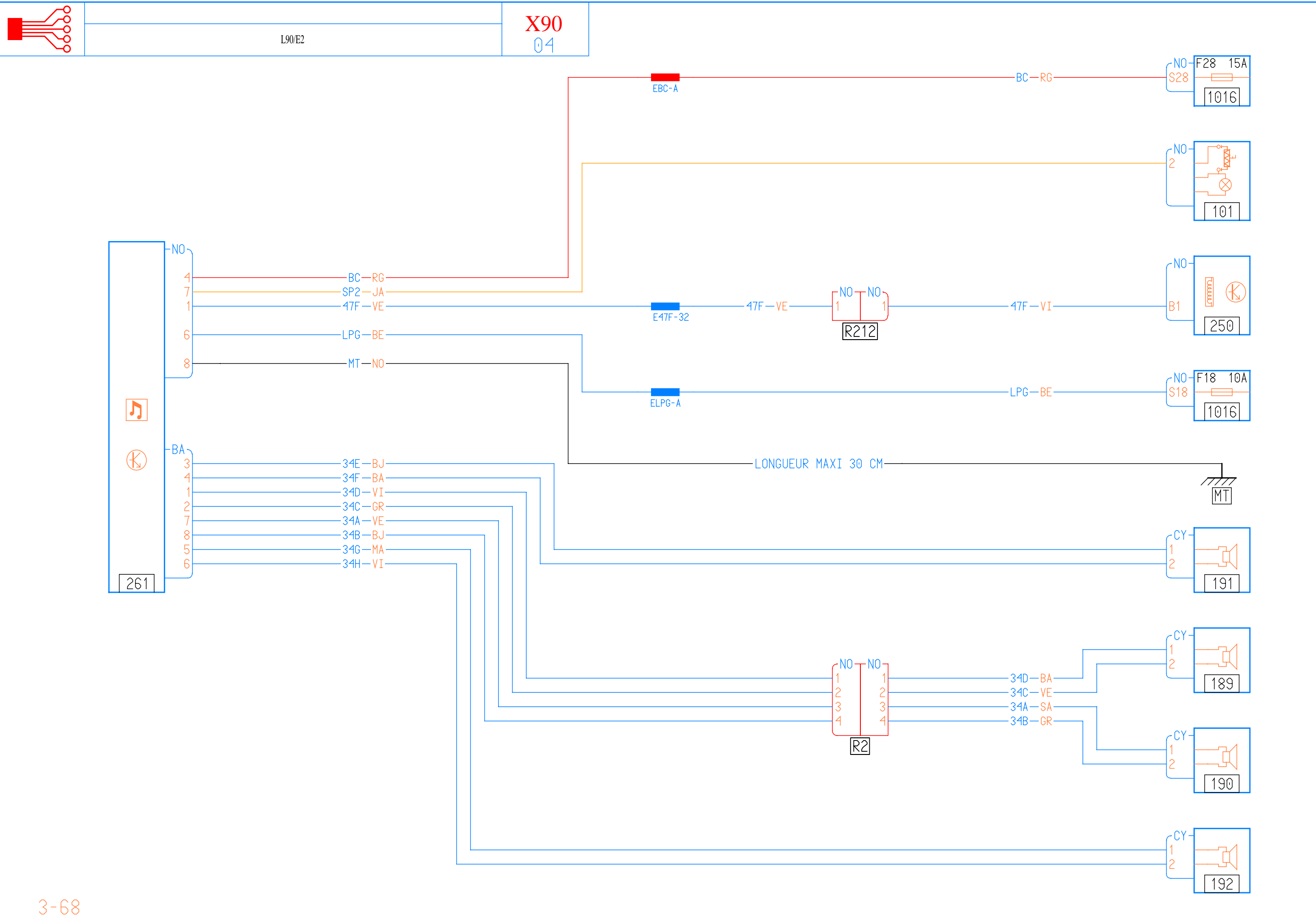



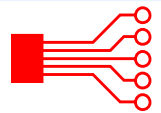

L90/E0/SRADIO

X90  
04

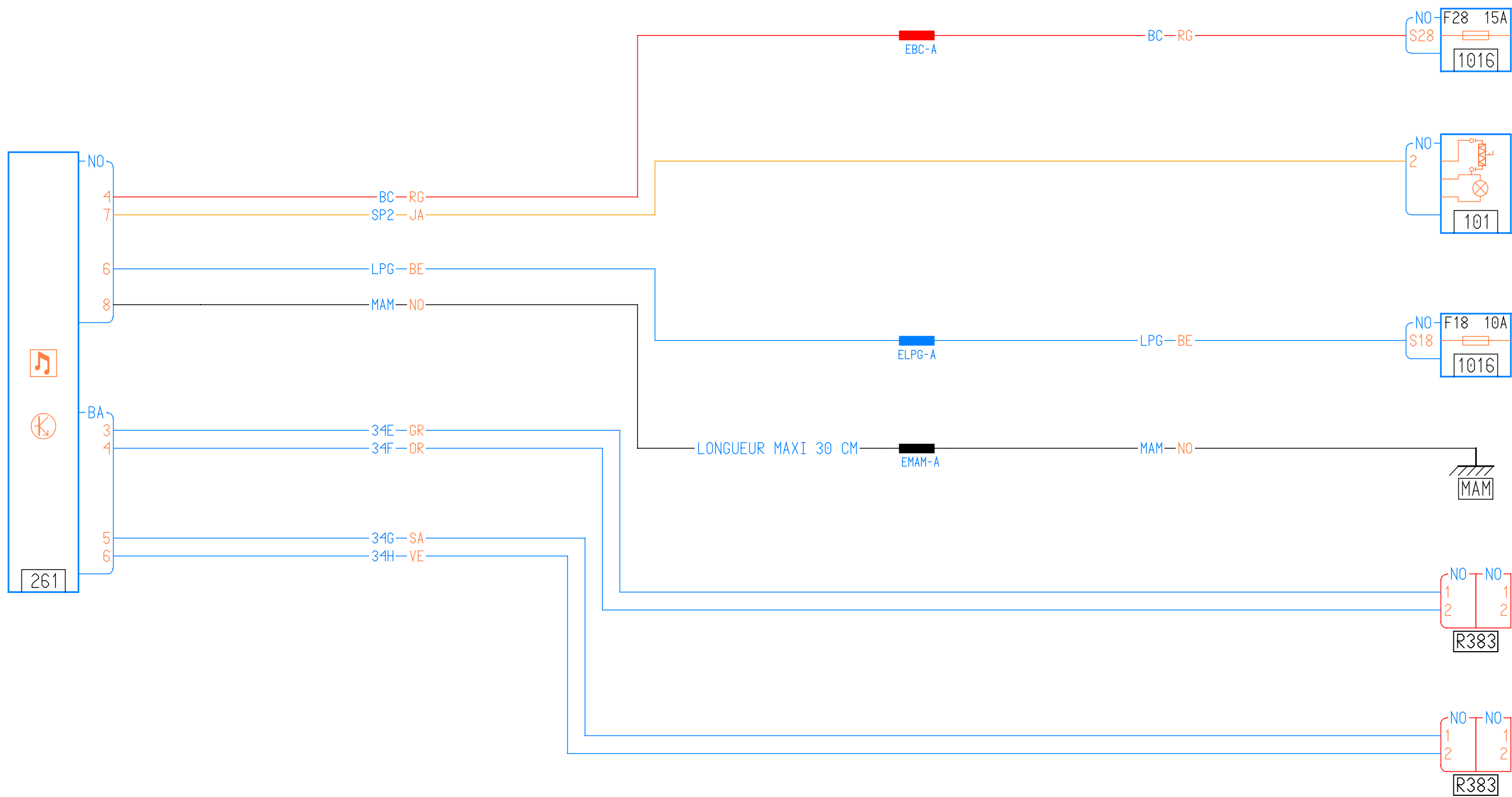

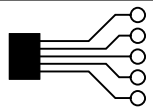

L90/CA

X90

04

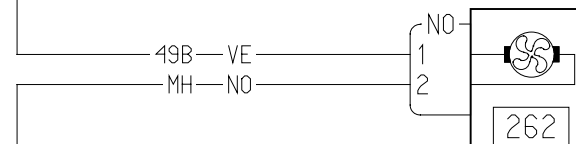
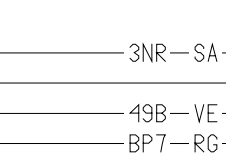
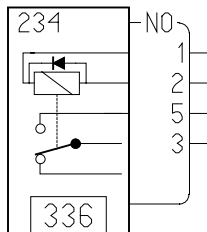
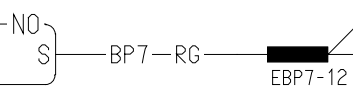
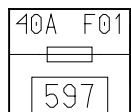
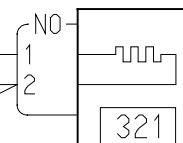
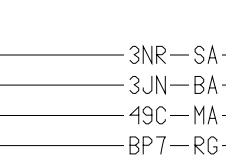
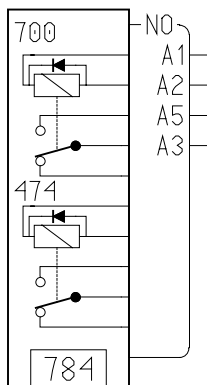
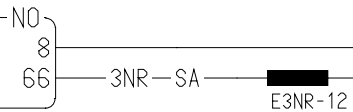
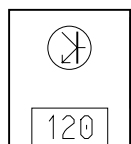

3-70

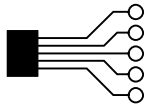

L90/CHAUF0

X90

04

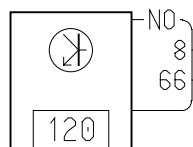

3NR-SA  
E3NR-12

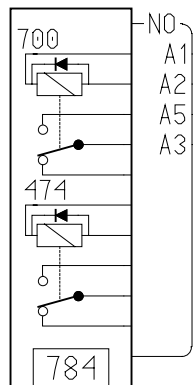

3NR-SA  
3JN-BA  
49B-SA  
BP7-RG

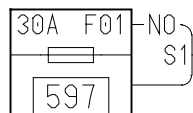

MH-NO

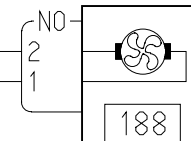

3-71

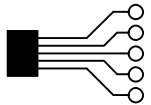

L90/RETROE

X90

04

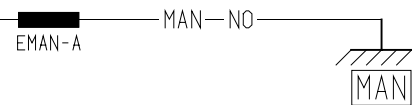
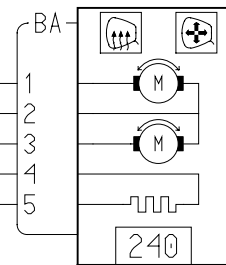
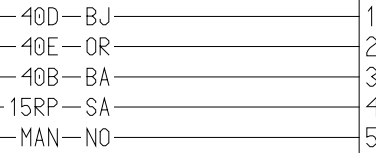
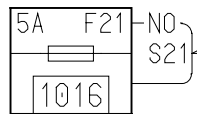
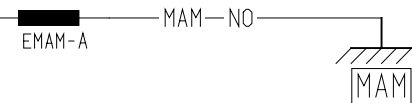
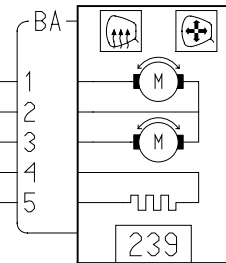
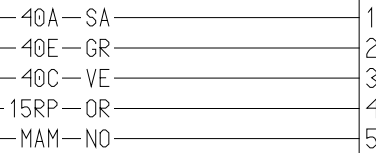
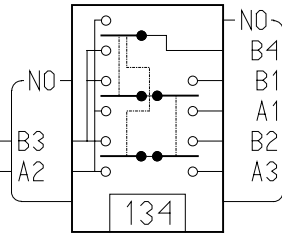
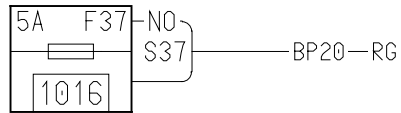
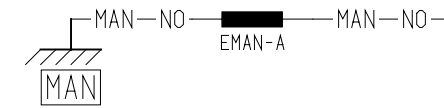

3-72

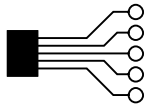

L90/SGACHA

X90

04

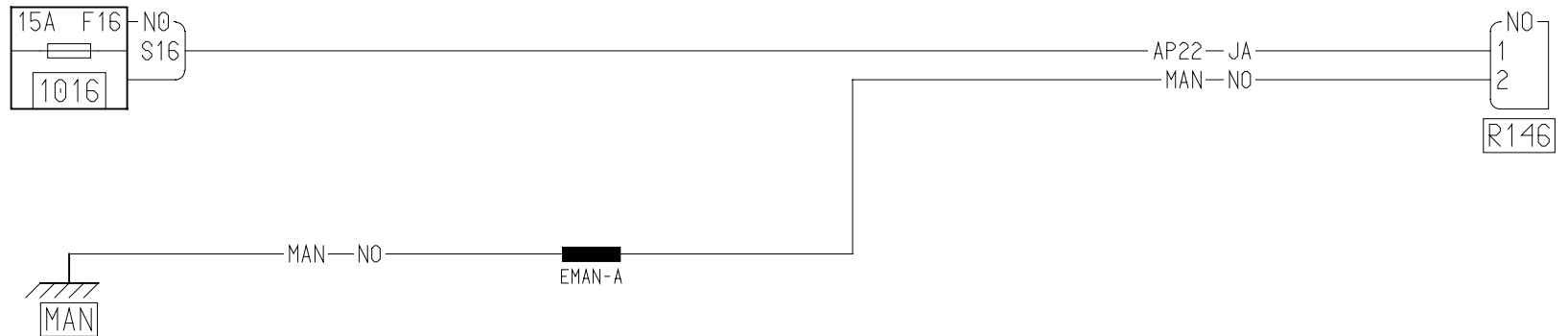
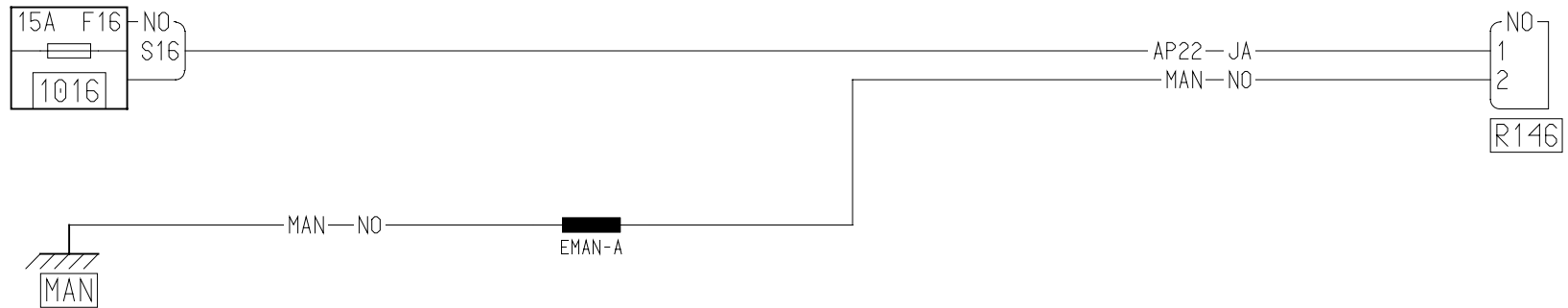

3-73

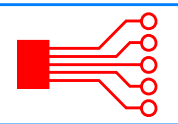

L90/E2/ESS/ABS/PROJAB/ADAC/ABPA01/E03A

X90  
04

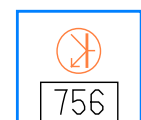
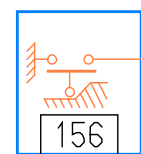
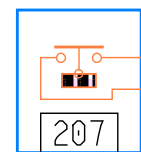
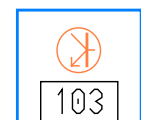
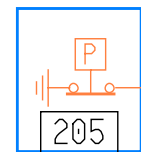
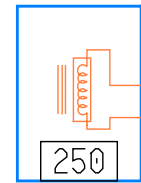
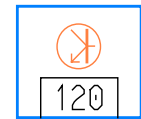
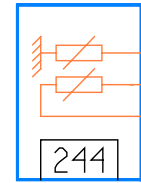
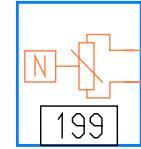

80T-OR

47A-SA

41A-OR

42A-GR

137C-VE

31A-GR

H7-BJ

47F-VE

28A-SA

2A-OR

H1-GR

H1-GR

60A-OR

NC-NO

8B-MA

9P-BA

LPG-BE

AP29-JA

BC-RG

60CD-VE

87H-VE

4Y-SA

4Z-VE

47H-VE

RPG-SA

CPG-OR

64E-MA

15LP-BJ

47K-VI

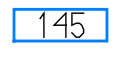
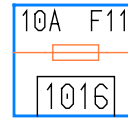
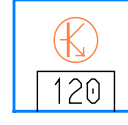
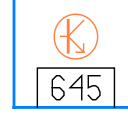
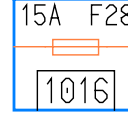
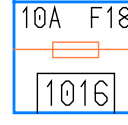
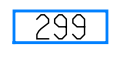
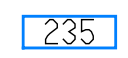
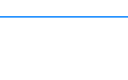
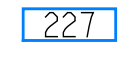
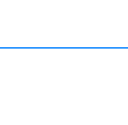
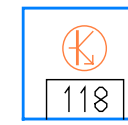
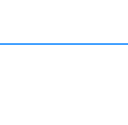
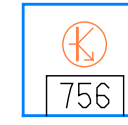
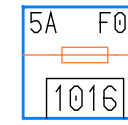
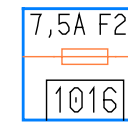
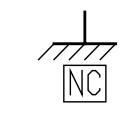
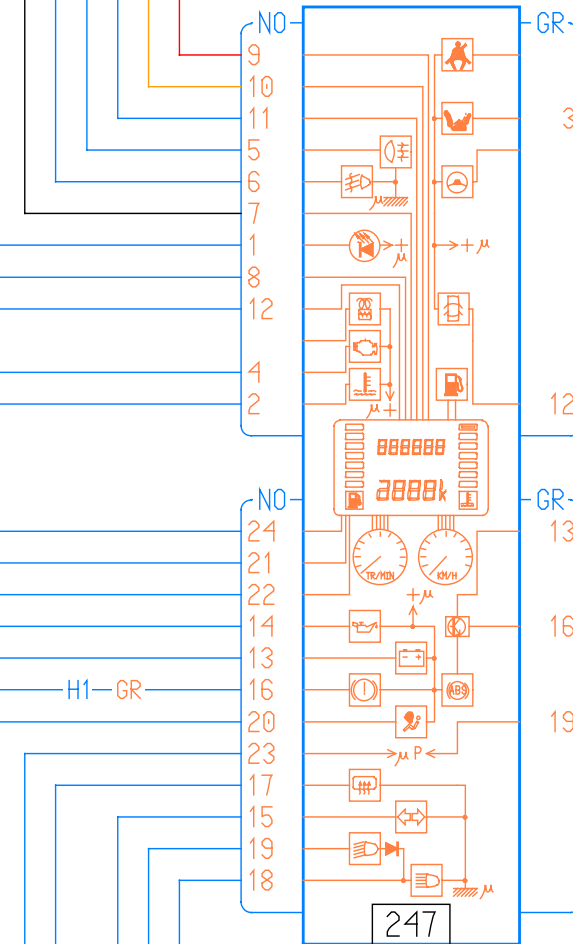

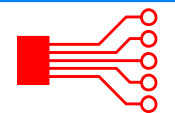

L90/E1/ESS/SSABS/PROJAB/E03A

X90  
04

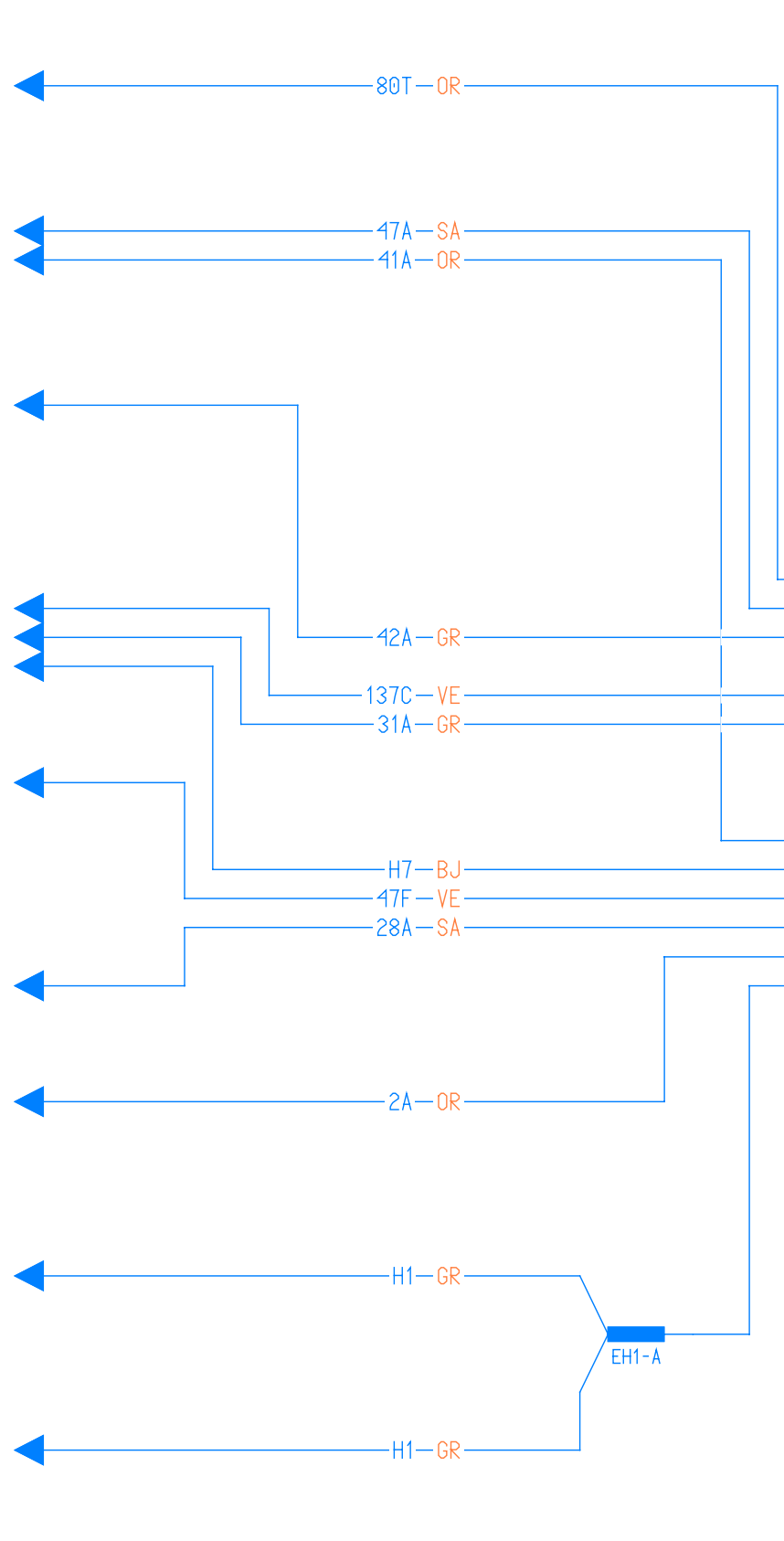
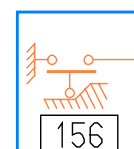
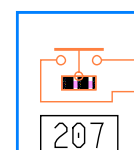
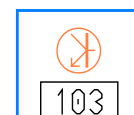
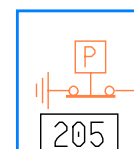
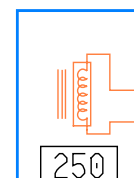
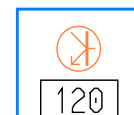
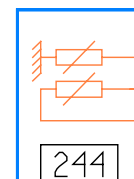
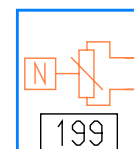

EH1-A

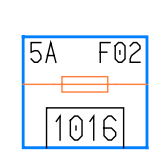
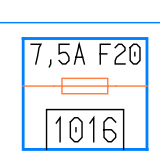
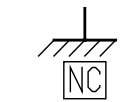
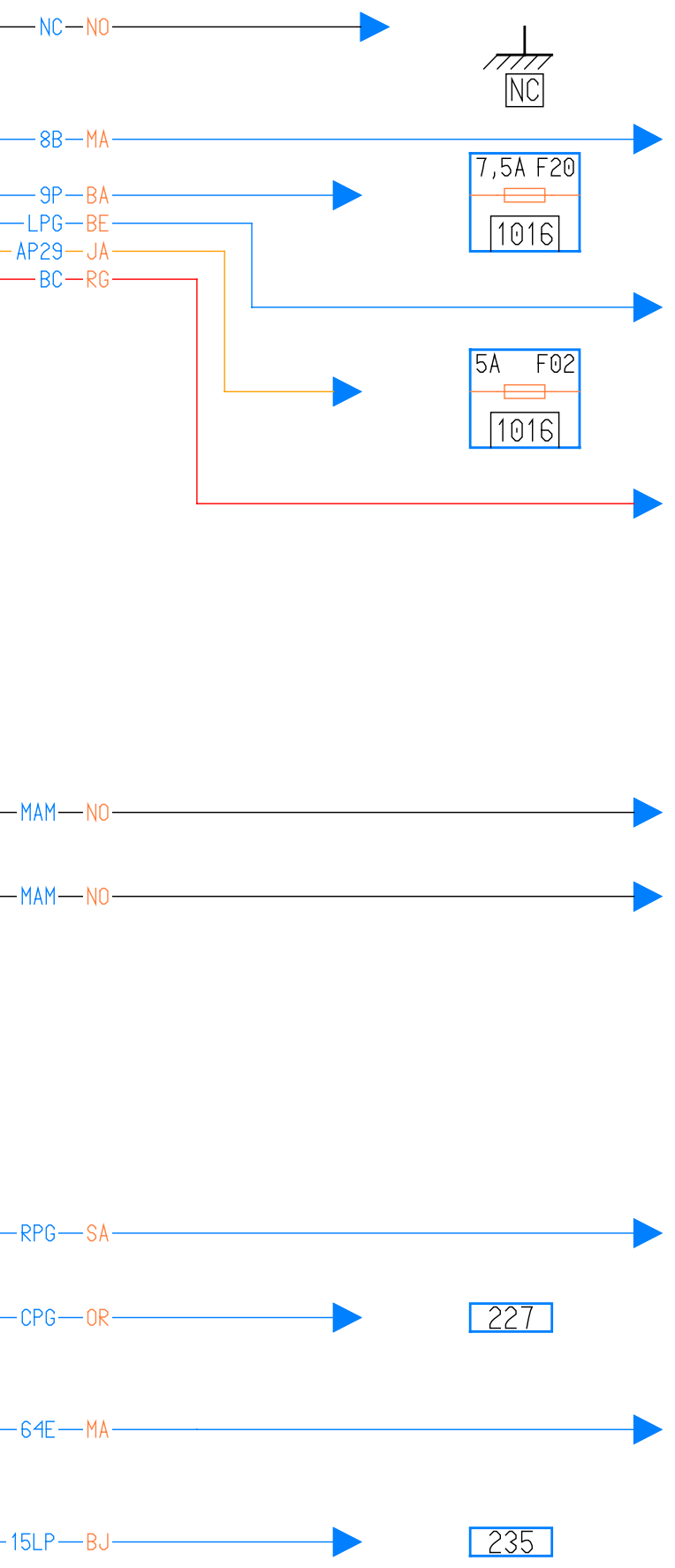
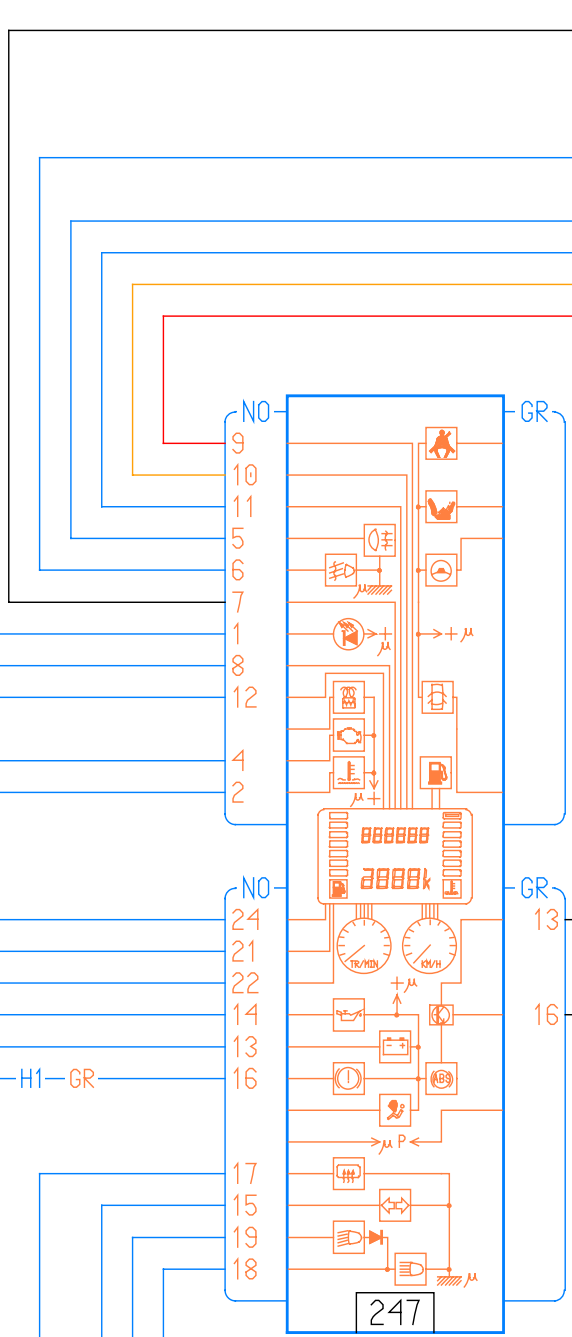

299

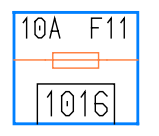
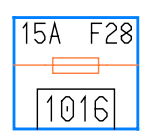
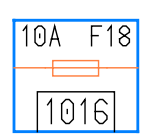

227

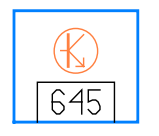

235

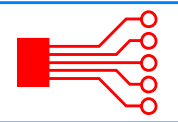

L90/E0/ESS/E03A

X90  
04

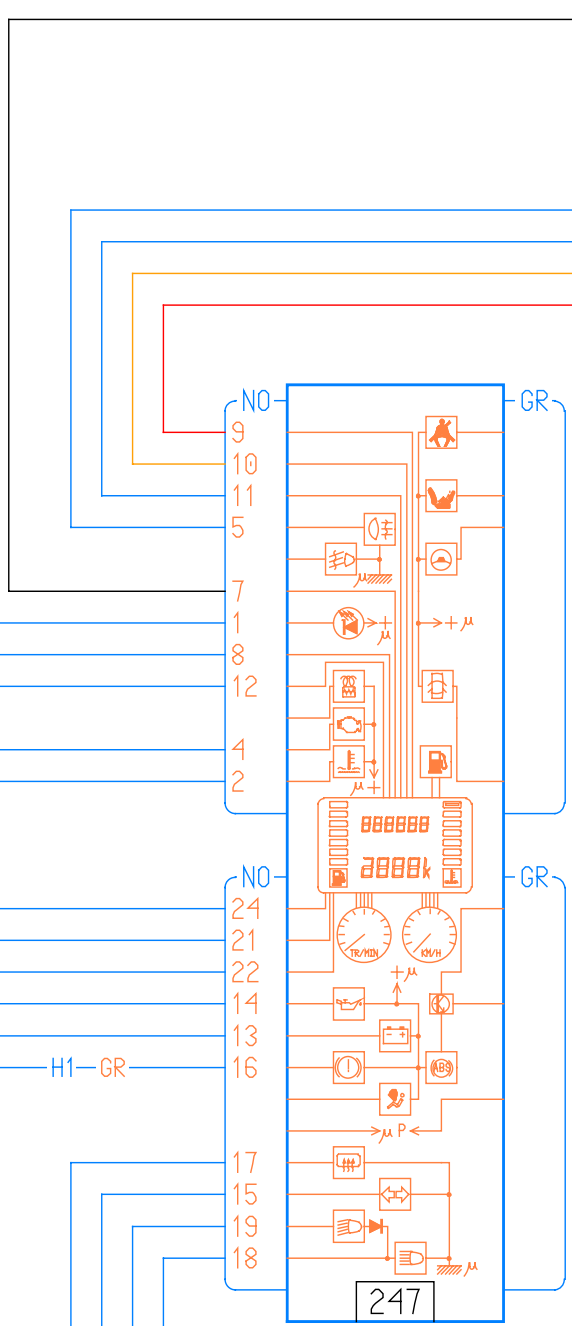
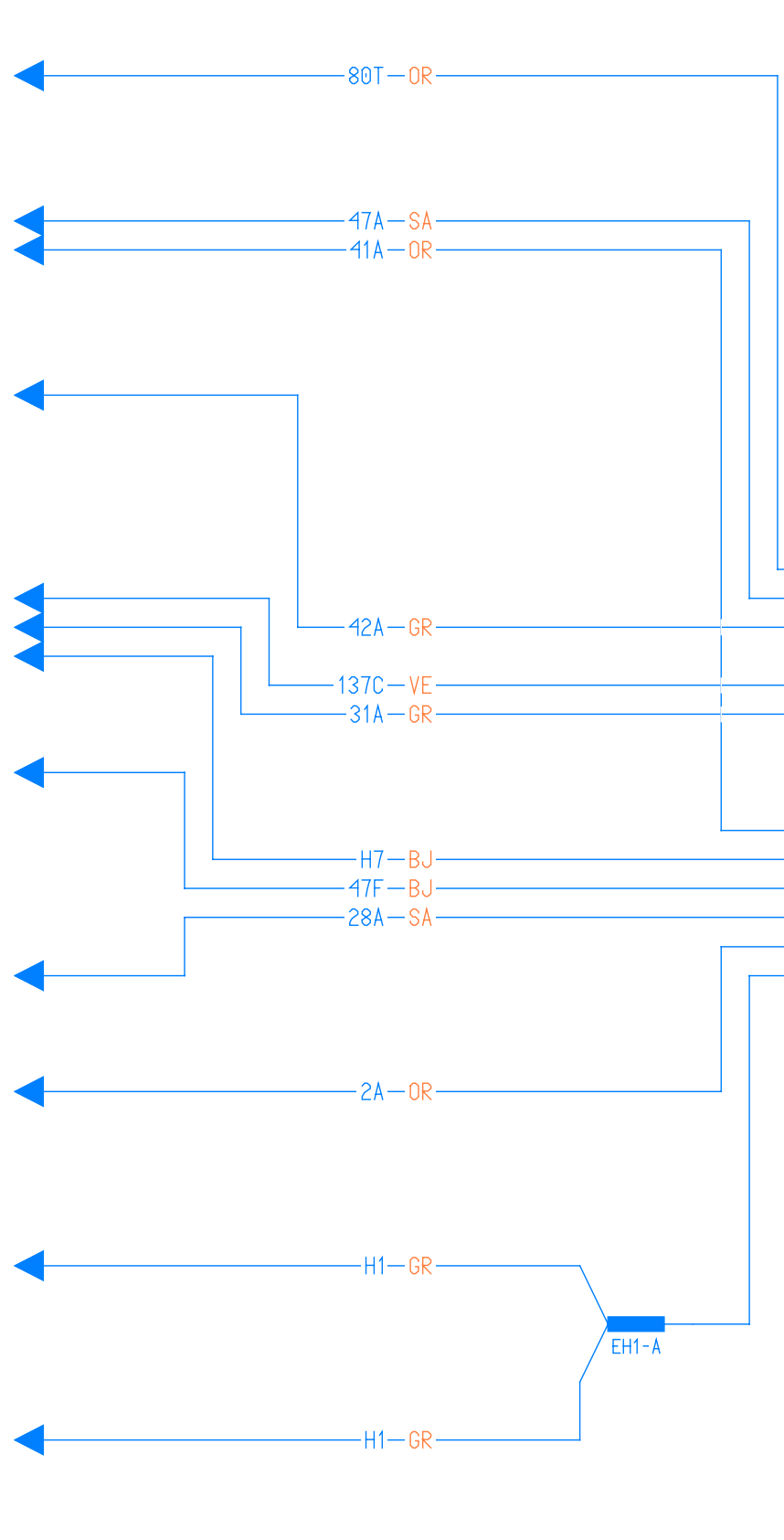
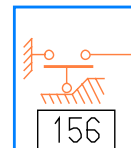
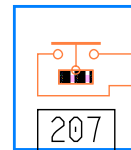
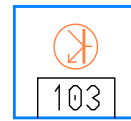
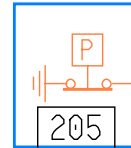
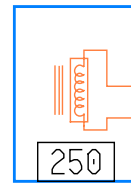
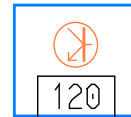
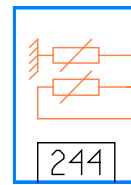
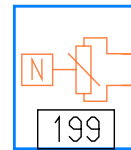
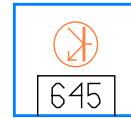

NC-NO

9P-BA  
LPG-BE  
AP29-JA  
BC-RG

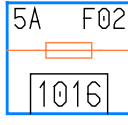
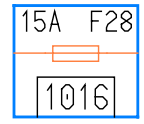
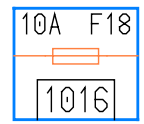
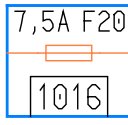

RPG-SA

CPG-OR

64E-MA

15A-BJ

227

128

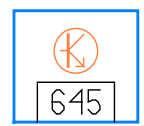
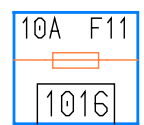



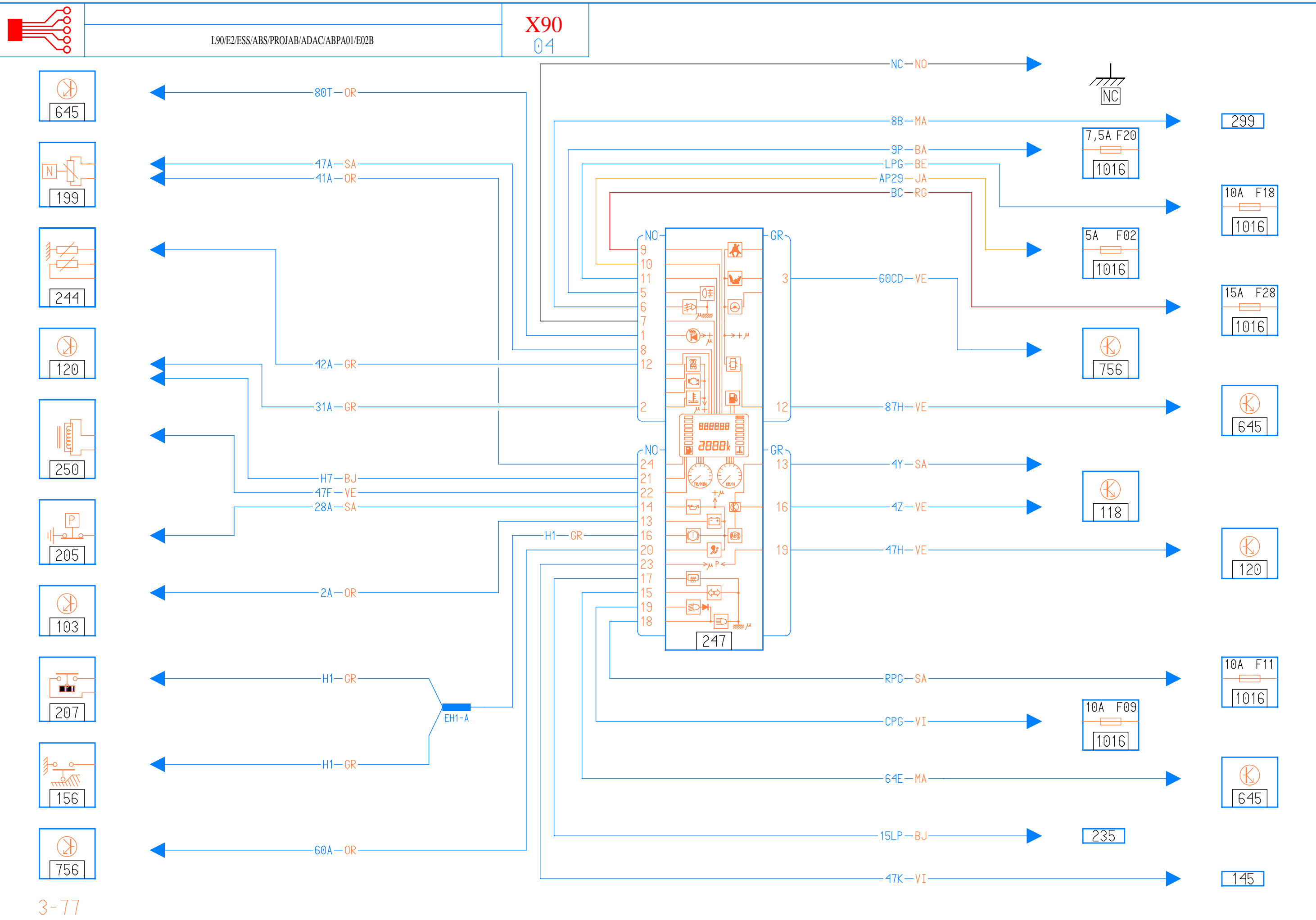

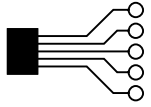

L90

X90  
04

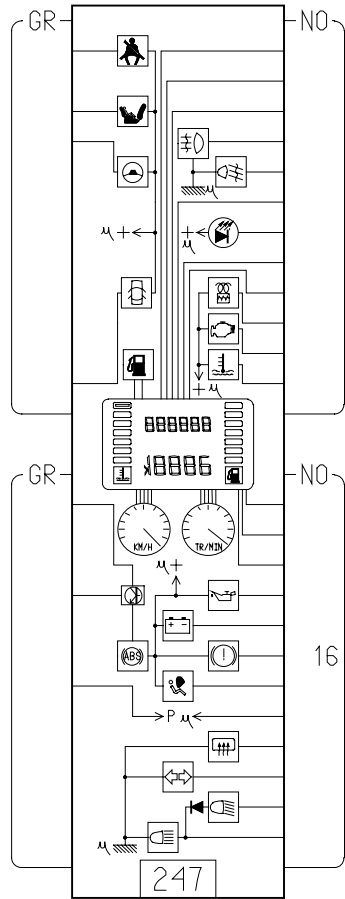

16

H1-GR

EH1-A

H1-GR

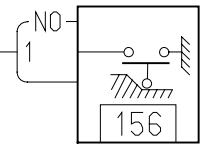

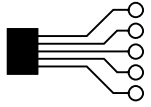

L90

X90  
04

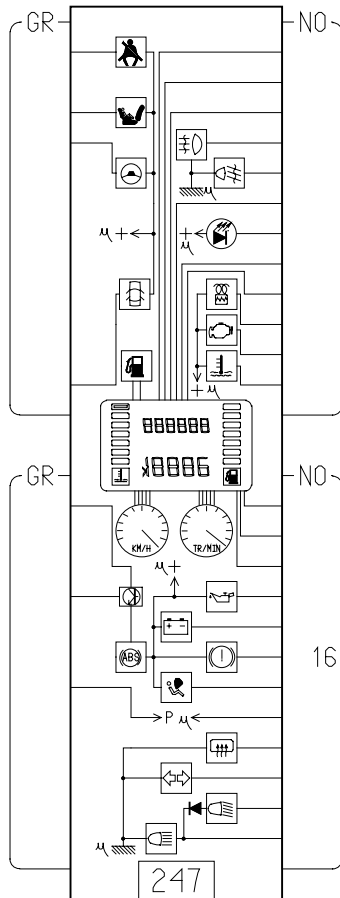

16

