

Understanding And Maintaining The BMW /2 Electrical System

by Doug Rinckes

with contributions from
Kees van der Heiden

History and Copyright

History

<i>Title</i>	<i>Authors</i>	<i>Version</i>	<i>Year</i>	<i>Description</i>
Understanding and Maintaining the BMW /2 Electrical System	Doug Rinckes Kees van der Heiden	1.0	2002	First released version

Copyright

This document is copyright © 2002 by Doug Rinckes (doug.rinckes@iname.com).

Permission is granted to copy, distribute and/or modify this document under the terms of the GNU Free Documentation License, Version 1.1 or any later version published by the Free Software Foundation; with no Invariant Sections, with no Front-Cover Texts, and with no Back-Cover Texts.

Table of Contents

- History and Copyright.....2
- History.....2
- Copyright.....2
- Introduction.....4
- Electrical System Overview.....4
- Understanding the Ignition System.....5
- The Magneto.....5
- The Points.....5
- The Capacitor (Condenser).....5
- The Coil.....6
- Adjusting The Spark.....7
- Checking the Magneto Position.....7
- Repositioning the Magneto Rotor.....7
- Setting the Timing.....8
- Understanding the Charging System.....10
- Wiring Guide.....10
- Maintaining the Generator.....10
- Maintaining the Regulator.....11
- Testing The Charging System.....14
- Test 1: No Load Voltage.....14
- Test 2: Cut-In Voltage.....14
- Test 3: Load Voltage.....14
- Test 4: Reverse Current.....15
- Look After Your Battery.....15
- What To Do.....15
- Ignition Problems.....16
- Weak Ignition Spring.....16
- Advance/Retard.....16
- Tutorial: How The Ignition System REALLY Works.....17
- What the Magneto is doing.....17
- Charts.....18
- Specifications.....20
- Replacement Parts.....21
- Wiring Diagram Colour Cross-Reference.....22
- Main Wiring.....22
- Turn Indicators.....23
- Wiring Diagrams.....24
- Connections.....24
- BMW Wiring Scheme #1.....26
- BMW Wiring Scheme #2.....27
- Ulrich Seiwert/Uli's Motorradladen Replacement Loom.....28

Introduction

This manual was written to help owners of /2 BMW motorcycles to service their bikes and keep them in running condition.

When these motorcycles were made, they had very different electrical requirements to motorcycles today, and used equipment which today's owner may not fully understand.

Doug and Kees hope that this manual is useful to owners of these motorcycles and that it will help owners keep their bikes where they belong - on the road.

Electrical System Overview

The BMW /2 motorcycles have what could be viewed as two electrical systems - one for the engine (ignition), and one for all the extras such as lights and the horn.

The ignition system consists of the magneto, coil, points and the sparkplugs. The ancillary system includes all the bulbs, the battery, generator, horn, and switchgear.

Because of this separation, it is possible for the engine to run quite happily despite major faults in the rest of the wiring system. Early electrical components weren't very reliable, and this was a major reason why many vehicles, and motorcycles in particular, had this kind of separation.

However, after the Second World War, other vehicle manufacturers started moving towards the coil system of ignition, and integrating the electrical systems together.

BMW remained with the split electrical system for some years, only changing to coil ignition and a single electrical system when the /5 motorcycles were released in 1970.

Understanding the Ignition System

At a very simplistic level, your /2 ignition works similarly to ignition systems today.

1. A charge is built up;
2. This is released as a voltage spike when the ignition points are opened by a cam on the end of the camshaft;
3. This spike passes through a coil which transforms it to an extremely high enough voltage;
4. This jumps the gap at the end of the spark plug, and thus ignites the fuel in the cylinder.

That was the simple version. The truth is somewhat more complex.

The Magneto

BMW equipped the /2 motorcycles with magnetos. These are the devices which build up the charge in our simple description of the ignition system.

Magnetos had two great advantages over coil ignition at the time:

1. They were much more reliable than early coils. (This is not an issue any more, and probably wasn't an issue by the 1960's either.)¹
2. The spark gets stronger as revolutions increase. Coil ignitions get a weaker spark at high revs - this is the reason why even today many racing engines use magneto ignition systems.

On the downside, magnetos were significantly more expensive to make, and a great deal heavier.

A magneto is made up of a magnet turning within a coil, creating an alternating current. The current is interrupted when the ignition points are opened, and the collapse of the current causes a voltage spike in a low tension coil - which is transformed by a high tension coil to give sufficient voltage for the sparkplug.

Since the current is generated by the magnet turning within the coil, the spark is at its weakest when the engine is turning slowly, and at it is strongest at high revolutions. For example, when turning it on the kickstarter, a comparatively weak spark is produced.

Unfortunately this is exactly when a strong spark is desired - this means that for easy starting, especially in winter, accurate setting of the magneto and ignition timing is required.

The Points

The points are fixed to the magneto, and are driven by the cam on the advance/retard unit. The ignition fires when the points are opened. They must be kept clean and dry - take care not to use so much grease on the lubricating felt that it gets onto the points.

Since there is only one set of points, both the sparkplugs fire together. The engine doesn't explode because only one cylinder has air/fuel - the other cylinder is in the exhaust stroke.

The Capacitor (Condenser)

The capacitor has two functions. When the points open, the current will try to jump the gap, and would spark violently. These sparks would quickly damage the points, and they would also delay the current cut-off and reduce the strength of the spark. The capacitor helps to smooth these out.

The other function of the capacitor is to provide a relatively long discharge, so that the spark is maintained long enough to ignite all the fuel/air mixture.

Normal capacitor values are between 0.1 and 1 μF . These values are not critical, as they are a compromise between a high value for low revs, and a low value for high revs.

¹ One area where magnetos are still used for their reliability is in light aircraft engines.

Although there is no really good way to prove a capacitor is OK, there are three common faults:

- No spark at the plug at all. The capacitor may be shorted out.
- Lots of sparks at the points, and a weak spark at the plug. The capacitor has an internal break, so is effectively not there.
- Engine starts OK cold, but when hot, gets hard to start. This can be caused by a capacitor with an internal leak.

Capacitors are cheap and small. Carry a spare and if you have ignition troubles, it is not a bad idea to try changing the capacitor.

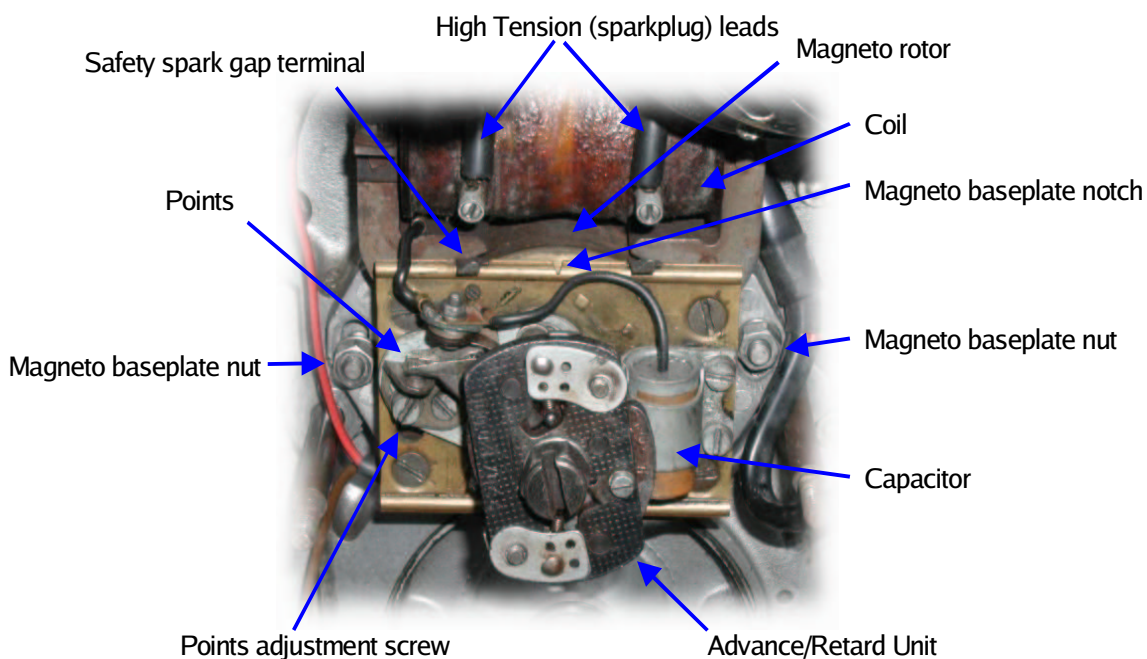

The Coil

The coil is mounted on the magneto body, and below the sparkplug lead terminals there are two small metal pointers. The distance between these pointers and the terminals should be 10-11mm. This allows the spark to jump to earth when it can't discharge normally (for example the sparkplug cap is loose). If this distance is too far, the coil may try to discharge through the coil insulation, which will quickly damage the coil.

Coils also fail through overheating. A coil which is failing in this way will allow the bike to run when cold, but may stop when hot. Once it has cooled down, it works fine. This can be very frustrating!

To help cool the coil, air is pulled up the inside of the engine cover through a small filter into the carbs. Keep the small mesh filter clean and lightly oiled.

Adjusting The Spark

Because the magneto produces a comparatively weak spark at low revs, it is important to set it up correctly so that your bike is easy to start.

Firstly, the magneto needs to be set correctly, then the timing of the points needs to be adjusted.

Checking the Magneto Position

Important: Before adjusting the magneto, make sure that the S-mark is visible in the inspection hole.



The engine timing marks - S and F

The magneto rotor has two timing index marks, 180° apart, and the brass base plate has a small notch in its top edge.

When the S-mark on the flywheel is in the middle of the inspection hole, these two marks need to line up.

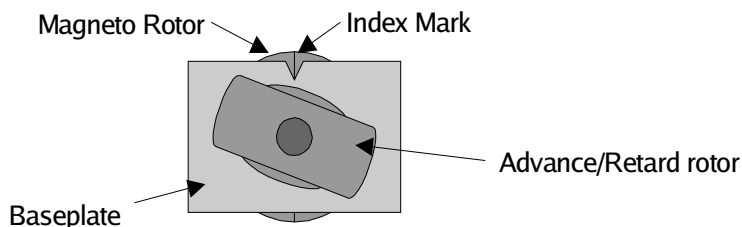

The marks can be easily seen by shining a light from the side, and looking over the front mudguard. This will cast a shadow in the line on the magneto rotor. (This line is impossible to see when shining the light directly at the rotor.)

If the marks are only a little out of line, you can loosen the two M6 nuts that hold the magneto body to the timing cover, and turn it, as there is a small amount of adjustment possible.

If the error is large, you will need to remove the magneto body, then remove and reposition the magneto rotor.

Repositioning the Magneto Rotor

The magneto rotor is a taper fit on the camshaft, and is not keyed so that its position can be adjusted. To remove the magneto assembly, remove the bolt which retains the advance/retard mechanism, and then the advance/retard mechanism itself.

Put this somewhere safe - they are very expensive and difficult to replace.

Disconnect the leads from the magneto body - the two high tension leads from the sparkplugs and the earthing lead - and remove the magneto body.

Removing the Rotor

There is now nothing holding the rotor on apart from the taper fit - but even so you will probably not be able to remove the rotor by pulling on it.

Cut yourself a length of M6 bolt - 50-55mm (about 2" to 2¼") should do. Put this down the hole in the center of the rotor. Replace the original bolt and carefully do it up. This will press the rotor off the end of the camshaft. You may have to do the bolt up quite tight before the rotor will come off the shaft.

Warning: Do not use a soft metal, such as a nail, or a rod of a smaller diameter, as rather than pressing the rotor off the camshaft it will probably just bend, and may be virtually impossible to remove without replacing the camshaft. This is, not surprisingly, expensive.

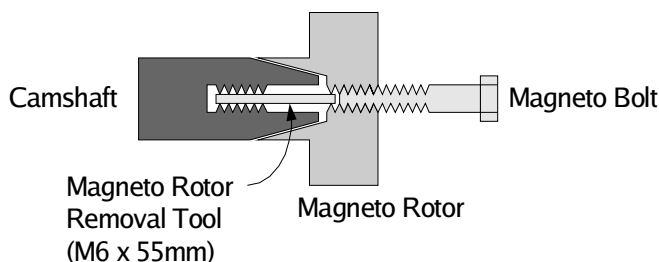

Making sure that the S-mark is still centered in the flywheel inspection hole, replace the rotor so that the timing lines on the rotor are vertical. Don't press the rotor on - you may want to adjust it once the magneto body is installed, so make sure it can still be turned on the camshaft.

Then replace the magneto body onto the timing cover and do up the mounting screws. Place it in the middle of the adjustment range.

Install the advance/retard mechanism, and do up the magneto bolt. Hold the rotor with your finger to stop it moving, as the rotor will turn on the camshaft, and hold it so that the lines on the rotor match up with the mark on the magneto plate. BMW specify 14.5 ft lbs for the torque setting, but 'tight' is probably sufficient.

Check:

1. The S-mark should still be centered in the flywheel inspection hole.
2. The lines on the magneto rotor should align with the notch in the magneto plate.

Setting the Timing

The drawback of magneto ignition is that the spark is weak at low revs. Unfortunately, starting a bike with a kickstarter means extremely low revs - so to start the bike, the timing needs to be set exactly right.

When adjusting the timing, first ensure that the magneto is set correctly - that is, the mark on the rotor and magneto body line up when the flywheel is at the S-mark.

Secondly, check and set the points to the correct gap (0.016", 0.4mm).

Then, totally ignore what the workshop manual says. The manual tells you to adjust the timing by loosening the screws that mount the magneto body and turning it. This will adjust the ignition timing, but it will also ruin the magneto body and rotor alignment.

So, this is how you set the timing:

- Remove the advance/retard unit.

- Loosen the two screws that hold the points to the magneto body, and turn the points plate a little.
- Do up the screws, and replace the advance/retard unit.
- Check the timing, and repeat until you get it right!

If you are setting the timing statically, it is correct when the points open and close just on the S-mark.

Take care while removing and replacing the advance/retard unit not to disturb the magneto rotor.

Confirm when finished that when the S-mark is visible in the flywheel inspection hole, that the marks on the magneto rotor and magneto plate still align.

Always carry out fine adjustments using a timing strobe light if you can.

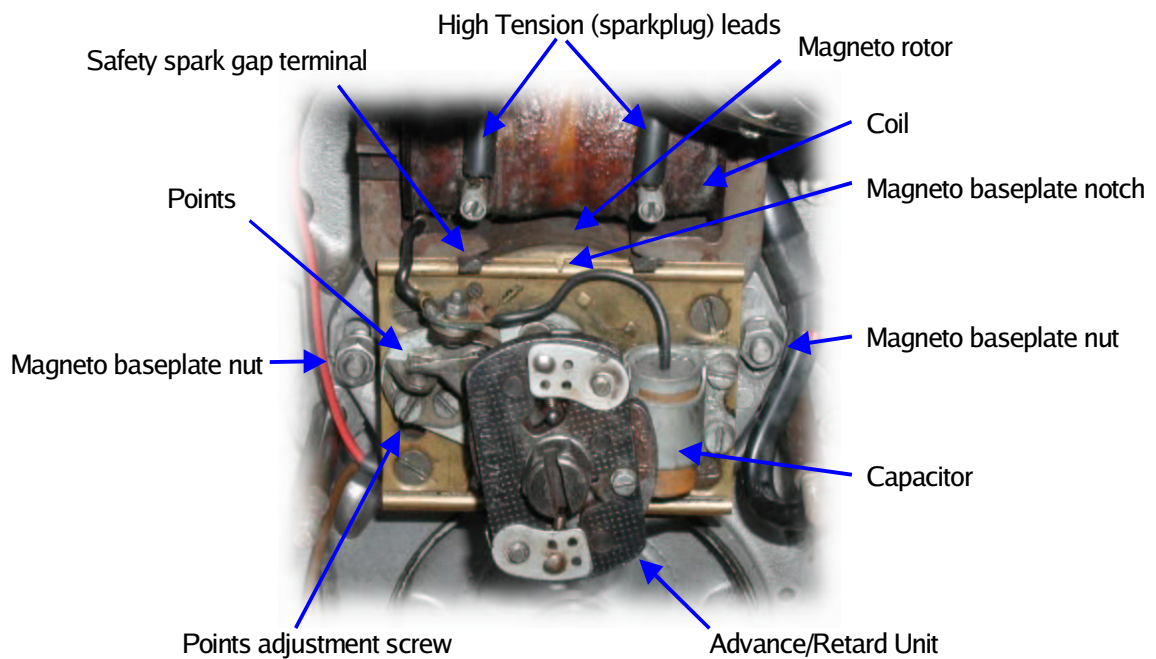

Understanding the Charging System

Most /2 BMWs are equipped with a 6 Volt 60/90 Watt DC generator (dynamo) and a mechanical Bosch regulator. Only a few models had equipment that differed from this.

The generator is mounted on the crankshaft, and produces a current and voltage that depends on the speed of the crankshaft.

However, for the charging of the battery and the rest of the electrics, we need a constant voltage. This is the job of the regulator.

The regulator keeps the voltage within the range of 7 to 8 Volts, by either dumping it to ground (if the voltage is too low), or shorting the field winding (if the voltage is too high).

It also protects the generator from too high a current, and prevents the battery from draining itself through the generator when the engine is not running.

Wiring Guide

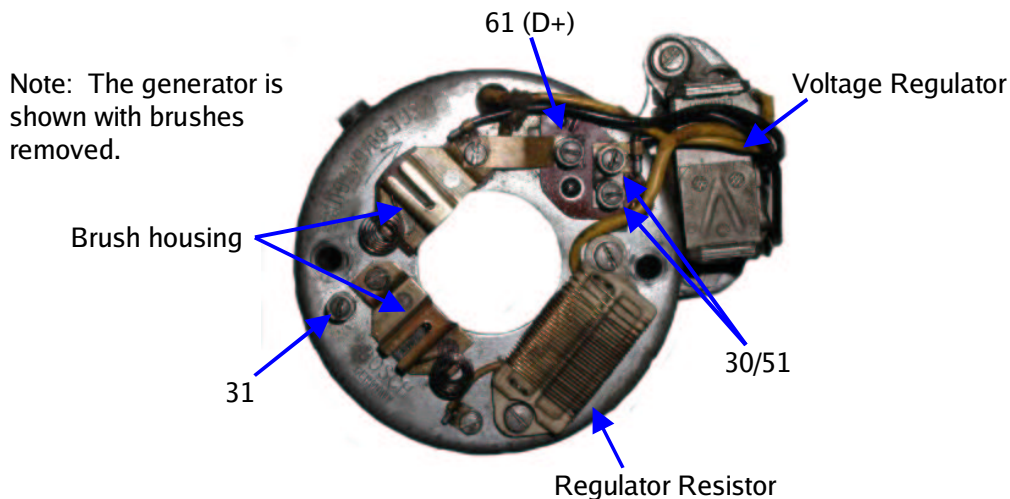

Maintaining the Generator

The generator consists of a spinning rotor, which has a commutator and two brushes to pick up the current. The rotor and field windings should last nearly forever - although they may be damaged if they have been overloaded or overheated. The /2 singles also wear out their generators because of their vibration.

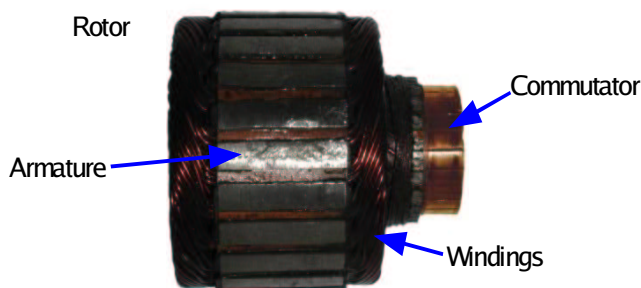

The rotor can be easily checked as follows:

- There should be no connection between the commutator and the armature.
- If the commutator shows burnt spots, the winding for those segments is probably broken.

The only things that wear are the brushes and the commutator. Check that the brushes are long enough and move freely in their holders. The commutator should be slightly glossy. If it is not, or it has dark burnt spots, it can be turned down on a lathe.

After turning, the isolation between the copper segments must be carefully cut back. Using an ohmmeter, check the resistance between adjacent segments of the commutator. This should read approximately 0.1 Ohm. Then measure between each segment and the iron core - this should read infinity.

Measure the resistance between 61 D+ and F - this should be about 2.5 to 4 Ohm.

Sometimes when the generator has been disassembled or the battery has been connected the wrong way around, the generator won't work. When you start the engine, there is no voltage coming from the generator, so the field windings get no current. This would prevent the generator from working, except for the small amount of residual magnetism left in the field, which is enough to start up the generator.

When this residual magnetism is lost, or has the wrong polarity, you must repolarise the generator (send a current through the field windings). Just connect battery positive to D+ for a few seconds - you can do this by closing the circuit breaker contacts with your fingers. Watch out for the sparks!

Maintaining the Regulator

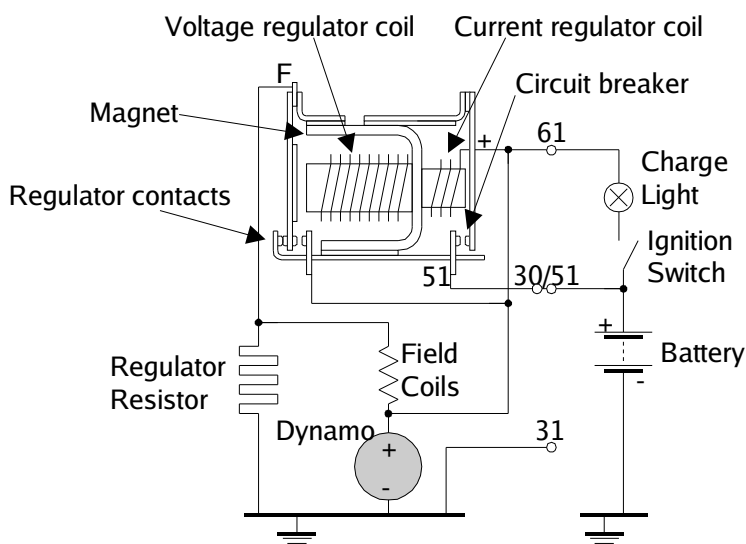

Two views of the same voltage regulator, with the connections identified. Note that the paper insulation around the coils is breaking down. This isn't really a cause for concern since the wires have an insulating coating.

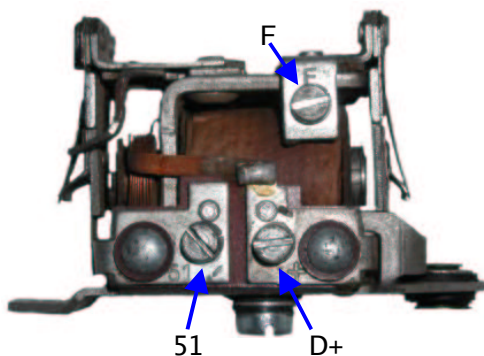

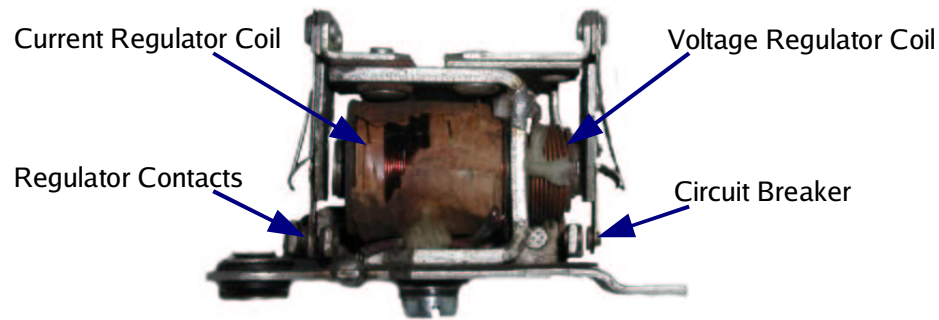

How The Regulator Works

When the voltage produced by the generator is low, the current flows through the field windings to ground. This works to increase the voltage produced.

When the voltage increases above 7 to 7.5 Volts, the current passes through a resistor which prevents the voltage from rising so fast.

If the voltage continues to rise, the voltage coil shunts the field winding (both ends connected together), which prevents it from flowing current. The voltage produced by the generator then drops to zero.

The current coil of the regulator measures how much current is flowing from the generator to the battery and all other electrical components. It works to drop the voltage if the current rises too much.

The regulator also has a circuit breaker - this is normally open until the generator voltage rises above 6.5 Volts, when it closes and opens a path from the generator to all the consumers. When the voltage drops, the current coil is wound so that the battery drains into the generator, and the current coil presses the circuit breaker open.

Replacing the Regulator

The regulator is a big compromise in order to get good results in normal conditions.

The biggest problem is the function of the current coil. It protects the generator from currents that are too high, but as soon as there is a current flowing it is acting to regulate the voltage down. So with a rising current, the voltage drops gradually. This produces a compromise - the voltage is too high when the lights etc are turned off, boiling the battery, and it is too low when everything is switched on, causing the battery to be drained.

The regulator is also sensitive to temperatures. The higher the temperature, the higher the generator voltage. The regulator is mounted in quite a hot place, so at least the battery shouldn't starve - but it might cook in summer.

The best compromise is to use a 14Ah battery, and have the regulator adjusted at the low end of the voltages. Keep an eye on the battery, and if it is draining, give it extra load, such as by using the headlights all the time, for example.

The circuit breaker isn't great either. It is switching currents of between 2.5 to 9 Amps, which isn't healthy for a mechanical switch. This is a major issue when riding for long times at slow engine speeds.

The solution is to use an electronic regulator - this does away with the problems of mechanical switch contacts, and most electronic regulators have a constant voltage over the whole current range.

An electronic regulator also has a diode to replace the circuit breaker. This acts as a one-way valve and only lets current flow in a single direction.

Not all electronic regulators are suitable - they must have over-current protection as well, so that when the current is too high for the generator, they switch off the field current.

But they are still temperature sensitive - they need to be kept below 80°C, so should be mounted outside

the engine, under the tank for example. Don't put it in the headlight - they don't like vibration and headlights vibrate a lot.

Testing The Charging System

To check the function of the generator and regulator, you will need a voltmeter with a 0.1 Volt precision and an ammeter. Analogue instruments are best - digital ones usually take too long to react to peaks, and cost more when you step on it. And you will step on it - eventually.

The following diagram shows the connections on the generator:

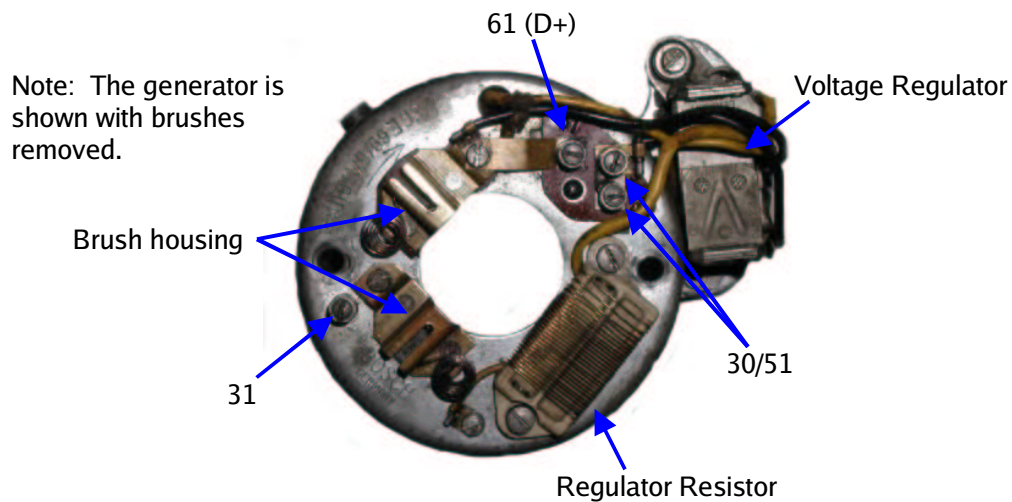

Test 1: No Load Voltage

Disconnect the battery, and switch off all lights, and any other electrical component. Connect the voltage meter between 61 (D+) and ground. Start the engine and slowly increase revs until the voltage no longer rises. Correct range is between 7.2 and 7.9 Volts. This ensures the battery is neither undercharged or overcharged.

Make sure the ground leads are securely connected, and that connector 61 (D+) is as well, otherwise you may burn out the field coils.

If the voltmeter needle is kicking during this test, this may be due to the generator brushes not making good contact with the commutator. Check the brushes are long enough, clean and that the tension spring is OK.

Test 2: Cut-In Voltage

With the battery still disconnected, connect the voltmeter between 61 (D+) and ground. Disconnect the lead from terminal 30/51, and connect an ammeter between this lead and terminal 30/51. Start the engine, and slowly increase revs until you see the ammeter jump or kick. When that happens, the voltmeter should read between 6.4 and 7.1 Volts.

If this voltage is too low, the electrical system is powered by the battery which will discharge too quickly. If the voltage is too high, the regulator contacts may be damaged because it will be switching a higher than normal current.

Test 3: Load Voltage

Leaving the battery disconnected, run the engine at operating speed, switch on the lights and press on the brake switch (this is very roughly about 60 Watts). Connect the voltmeter between 30/51 and ground. It should read between 6.5 and 7.4 Volts.

If the voltage is too high, the generator is overloaded and may burn. If too low, the battery charge will be insufficient.

Test 4: Reverse Current

Use the same process as for Test 2: Cut-In Voltage - but the ammeter must be able to read negative currents. If it cannot, reverse its connections.

Increase the engine speed until the circuit breaker closes, then slowly drop the revs. The current from the battery to the generator will slowly fall to zero, then when the revs drop still further (you may need to adjust the idle speed), the current will fall indicating a reverse current flowing from the battery to ground. When this reaches -2 to -7.5 amps the circuit breaker should open and the ammeter should indicate zero current.

If the reverse current is too high, the circuit breaker points may stick and burn the generator, or drain the battery.

Look After Your Battery

Always keep a close eye on your battery. If it is losing a lot of water, then the regulator must be adjusted lower. If it is always drained, adjust it higher, however see the next section.

An alternative may be to try varying the load you place on the electrical system, by using the lights more or less.

What To Do

The BMW repair manual cops out at this stage recommending that you return the regulator to a Bosch maintenance center for adjustment.

The large nut on the bottom of the regulator is sealed with lacquer - it is probably best not to play with this.

It may be possible to adjust the regulator by bending the springs, but great care will be needed and unless you know what you are doing, you will almost certainly only make matters worse.

Ignition Problems

Weak Ignition Spring

The ignition switch has a spring in it - on the singles this spring controls the contact that makes sure the battery voltage is connected to the ignition system. If this spring is weak, or the contacts are too far apart, either no connection is made or an intermittent connection - with ignition problems resulting.

If you suspect the ignition switch, you can run the engine by bypassing it. The ignition switch does two things - first, it switches power to the lights, and secondly, it stops the engine by earthing the magneto.

If you disconnect the earthing lead from the magneto (red/black or brown/black wire going to terminal 2 on the magneto), you will be able to kick start the engine. Note that you will have to stall the bike to stop it!

Advance/Retard

Again a singles problem - if you dismantle the advance/retard mechanism, the cam can be assembled 180 degrees out. Sparks will occur at the end of the exhaust stroke, which will prevent the engine from starting. However continued kicking will eventually fill the cylinder up with fuel, and the engine may kick back violently - which can hurt a lot.

Note that for all bikes, the cams eventually wear, and they don't wear at the same rate. When checking timing with a stroboscope, if two S-marks appear in the inspection window, then your cams may need examination.

R68/69 bikes are fitted with a manual advance lever on the handlebar. This retards ignition 10 degrees, to avoid pinging on low octane fuel. The cable turns a plate which holds the points on the magneto.

To set the timing on these bikes, fully advance the lever, with the clamp screw on the plate loosened. Start the engine, and adjust the manual advance lever until the S-mark is in the middle of the inspection window. Then tighten the clamp screw.

Tutorial: How The Ignition System REALLY Works

What the Magneto is doing

Usually the engine will run even if the magneto is not set perfectly, but there are times when it will make a big difference. Starting when it is very cold, if the pistons are worn, the carburettors need adjusting - all these circumstances require a very good spark.

The optimal setting for the magneto is called the Abrisz point. Abrisz can be roughly translated as "tear off", and what are being torn off are magnetic fields.

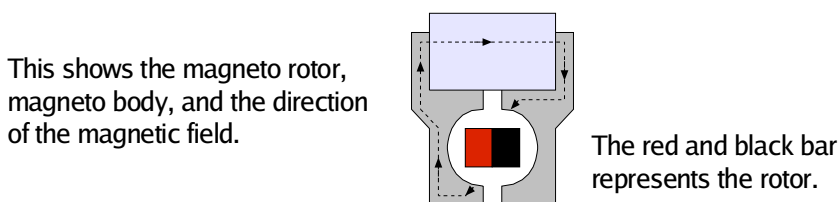

The following diagram shows how the magneto changes over half a camshaft rotation (one full crankshaft rotation).

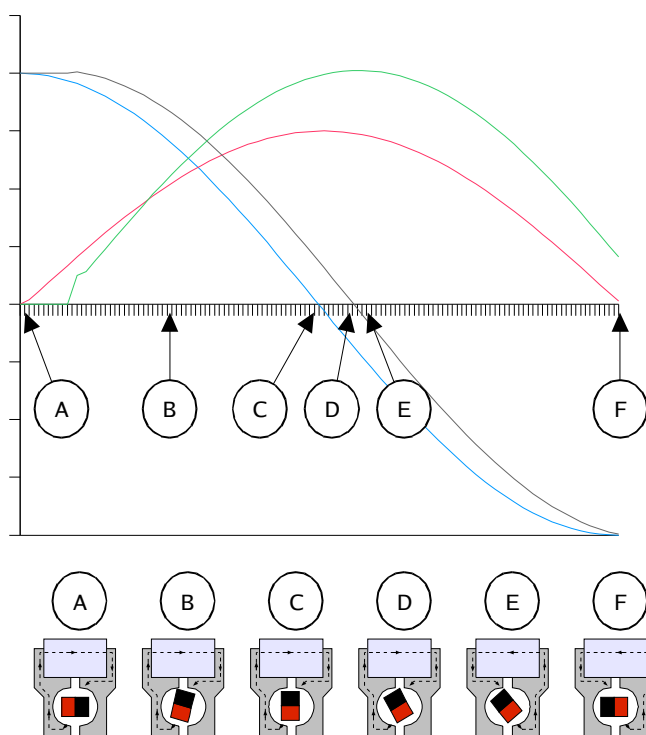

The blue line shows how the flux of the rotating magnet develops during half a revolution. (The position of the magnet, and the direction of the flux, is shown by the magneto pictures at the bottom.)

Now, the rotation of the magnet causes a current in the primary coil, which is proportional to the rate of change of the magnetic flux. This current causes its own magnetic field in the magneto body, which is null when the flux is constant, and maximal when the flux is changing. This is shown by the red line. (This line has been stretched vertically to make it more visible.)

The grey line is the sum of these two, and shows the point at which the magnetic field reverses direction.

Note that this is slightly later than when the magnet is vertical.

This causes a current in the coil which is shown in green. The best time to open the points for the strongest spark, is when this current is at its maximum. Note that this is the same as when the grey line crosses zero - this is the Abrisz point, since the magnetic field lines "tear off" from one pole and fly to the other.

Abrisz Point and Timing

An important note is that although the timing advances at higher revs, the Abrisz point does not. At high RPMs you are opening the points at a less effective moment, which reduces the strength of the spark.

There are, however, two other influences which help to maintain a good spark at high rpms:

- Firstly, the voltage is higher (since the magnet is turning faster);
- Secondly, the spark duration stays constant.

Charts

Kees made up a jig to mount his magneto on a lathe, so he could run it at various controlled speeds and observe its behaviour. These charts are based on his oscilloscope readings.

Where rpms are specified, these are crankshaft rpms. Remember the camshaft (and therefore the magneto) spins at half crank speed.

Chart 1: Two ignition pulses

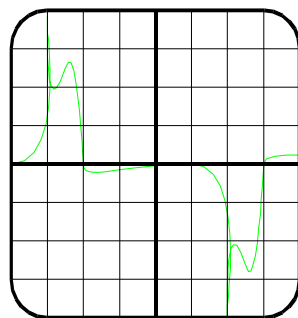

Horizontal scale: 10ms per division
Vertical scale: 10 volts per division

This shows two ignition pulses at 1040 rpm. When the points open the voltage rises and oscillates very quickly. These are called the primary oscillations, and are caused by the primary coil and capacitor interacting.

Then the voltage stays at around 20 volts, which causes the spark at the plug, then there are a bunch more oscillations (secondary oscillations) caused by the secondary coil, before the voltage drops back to zero.

The points close again at the center of our diagram (there is usually a small step in voltage at this point). The voltage doesn't rise much, despite the fact that the coil is charging, since the points are closed and the coil is short circuited. There is, however, a fairly high current at this point.

The next pulse is inverted, since the magnet has turned and the north and south poles have changed place.

Chart 2: Primary and secondary oscillations

This shows a closer view of the oscillation.

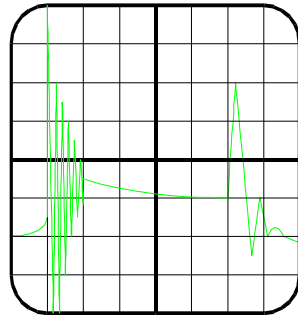

Horizontal scale: 1ms per division
 Vertical scale: 10 volts per division

Firstly, the voltage slowly rises a couple of volts. When the points open, due to the self-induction, the voltage spike is too large to fit on the screen.

The voltage then oscillates between the primary coil and the capacitor until it settles. About 5ms later, there is the secondary oscillation. This happens as the spark extinguishes, and the secondary coil is still at several hundred volts. The oscillations are caused because there is no current path, and these oscillations are transformed back into the primary coil (which is what we are measuring).

Interestingly, the spark lasts for about the same duration (5ms) at the higher speed of 6000rpm.

Chart 3: Missing capacitor

For this test, the capacitor was disconnected.

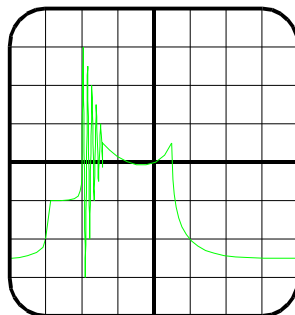

Horizontal scale: 1 ms per division
 Vertical scale: 10 volts per division

When the points close, all the arcing between the points delays the spark more than a millisecond. At 1040rpm crankshaft speed, 1ms is 6°, so a faulty or failed capacitor will retard timing by a significant amount.

This could help with a common problem - where there is not enough adjustment in the points plate to get the timing set correctly. In these cases, you may have a faulty capacitor.

Specifications

<i>Item</i>	<i>Setting</i>
Safety Spark Gap	10-11mm
Points Gap	0.4mm (0.016")
Spark Plugs	see Replacement Parts
Spark Plug Gap	0.6mm (0.024")
Headlight Bulb	Twin filament, 6V, 35/35W
Parking Light	Pilot Lamp, 6V, 2W
Neutral Indicator	Pilot Lamp, 6V, 2W
Charging Indicator	Pilot Lamp, 6V, 2W
Speedometer Light	Pilot Lamp, 6V, 2W
Tail and Stop Light	Twin filament, 6V, 5/18W
License Plate Light	Round bulb, 6V, 5W
Turn Indicator Bulb	Tubular lamp, 6V, 18W
Turn Indicator Unit	HELLA BI 81
Battery	6V, 8 amp hours (original)

Replacement Parts

The following is a list of parts which you can use to replace the standard items, where they might be too expensive, or simply unobtainable.

These are second choice - using the original is obviously preferred.

<i>Item</i>	<i>Original Part</i>	<i>Replacement Part</i>	<i>Notes</i>
Spark plugs R50, R60	Bosch W 240 T1	Bosch W4A2 BERU 14-5A (The old code for this plug was 240/14) Champion L81 NGK B7HS (14mm diameter, 1/2" reach)	Bosch recoded their plugs at some stage, so the original code does no exist any more. Depending on your local Bosch agent, it will probably be easier to source replacement plugs from one of the other manufacturers.
Spark plugs R50S, R69S	Bosch W 260 T1	Bosch W3AC BERU 14-4A1 (The old code for this plug was 260/14) Champion L4G NGK B8HS (14mm diameter, 1/2" reach)	As above.
Battery	6V, 8 amp hours	6V, 14 amp hours	Less likely to cause problems with weak charging systems.

Wiring Diagram Colour Cross-Reference

There were at least two different factory wiring schemes, with some cables having different colours. In addition to these, the replacement looms available today often have still different colour coding. This table provides a cross reference between them.

Main Wiring

The main difference between the two wiring schemes was the placement of the horn and headlight dimmer switches.

In Scheme #1, the headlight main and horn switches were in one switch block (on the left), and the indicator and headlight flasher switches were in the other (on the right).

In Scheme #2, the headlight main and headlight flasher switches were in one switch block (on the left), and the indicator and horn switches were in the other (on the right).

Both these wiring schemes are shown in the original BMW repair manuals, although only the first is shown in the owner's Instruction Manual.

<i>From</i>	<i>To</i>	<i>BMW Scheme #1</i>	<i>BMW Scheme #2</i>	<i>Ulrich Seiwert Replacement Loom</i>
Ignition 15	Stop Light Switch	Black-Violet	Black-Green Run from Horn terminal connected to Ignition 15.	Violet
Ignition 31	Generator 31	Brown	Brown	Brown
Charging Lamp	Generator 61	Blue	Blue	Blue
Ignition 2	Magneto 2	Black-Red	Brown-Black	Black-Red
Ignition 30/51	Generator 51	Red	Red	Red
Ignition 15	Horn	Black	Black-Green	Green
Ignition H	Horn	Black	Black	Green
Ignition 58	Three Pole Connector 3	Black	Black-White	Black
Ignition 31	Three Pole Connector 2	Brown	Not Used (Instead, Three Pole Connector 2 is connected to Ground using a Brown wire.)	Brown
Generator 30	Battery +	Black	Red	Red
Three Pole Connector 1	Stop Light Switch	Black-Violet	Black-Red	Not Specified
Neutral Indicator Lamp	Neutral Switch	Black	Black	Black
Battery -	Transmission Ground	Black	Brown	Not Specified
Three Pole Connector 1	Brake Light Lamp	Black	Red	Not Specified
Three Pole Connector 2	Brake and Tail Light Common	Black	Green	Not Specified
Three Pole Connector 3	Tail Light Lamp	Black	Black	Not Specified
Three Pole Connector 3	Side Car Socket	Black	Not Specified	Not Specified
Ignition H	Headlight Switch H	Not Specified	Black	Not Specified
Ignition 56	Headlight Switch 56	Not Specified	Yellow-White	Not Specified
Ignition 31	Headlight Common	Not Specified	Not Specified	Not Specified
Headlight Switch 56A	Headlight 56A (High Beam)	Not Specified	White	Not Specified
Headlight Switch 56B	Headlight 56B (Dip Beam)	Not Specified	Yellow	Not Specified

Turn Indicators

The Turn Indicators were an option, and do not feature on all bikes.

<i>From</i>	<i>To</i>	<i>BMW Scheme #1</i>	<i>BMW Scheme #2</i>
Two Pole Connector 1	Left Blinker Lamp	Black	Blue-Red
Two Pole Connector 2	Right Blinker Lamp	Blue	Blue-Black
Ignition 15	Blinker 15	Red	Green
Right Blinker Switch	Two Pole Connector 2	Blue	Blue-Black
Left Blinker Switch	Two Pole Connector 1	Black	Blue-Red
Blinker Switch 54	Blinker 54	Green	Green-Yellow
Blinker Switch 56A	Headlight 56A	Grey	White
Blinker Switch 30	Blinker 15	Red	Green

Original turn indicator switches are now quite rare.

Wiring Diagrams

Connections

Magneto

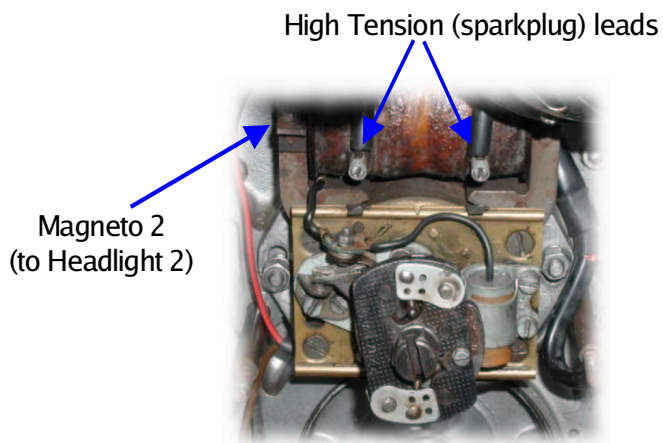

Generator

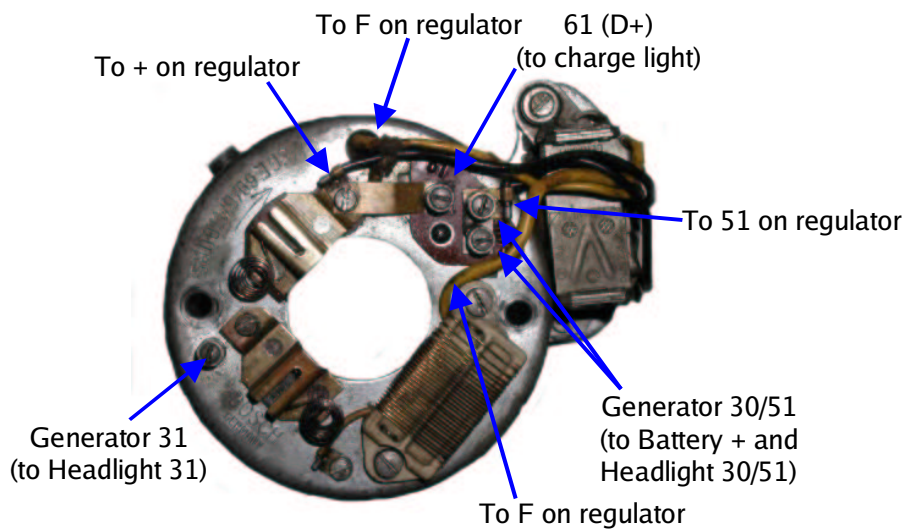

Regulator

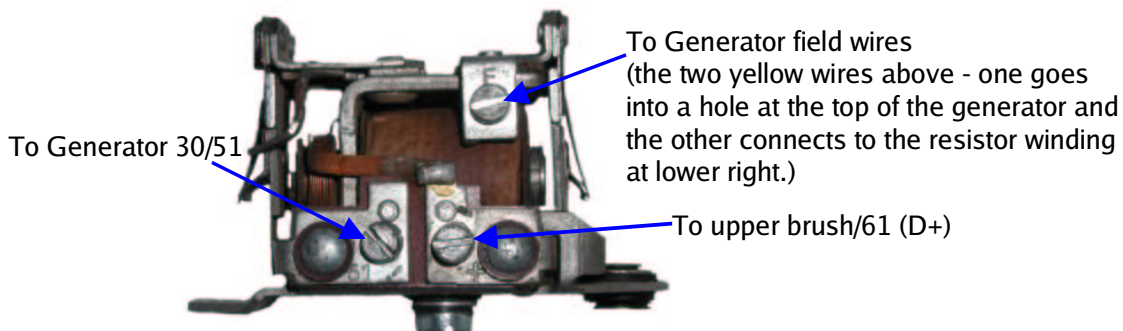

Ignition Switch

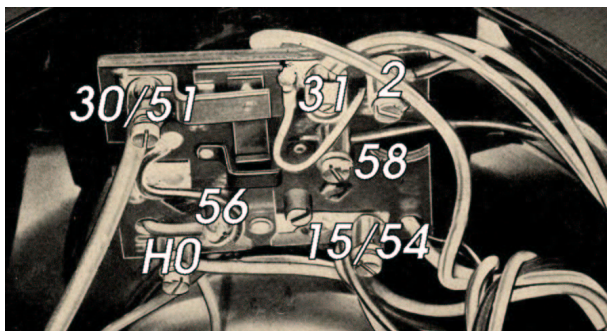

This view is taken looking into the headlight shell.

The following diagrams show the function of the ignition switch. Pushing the key into the switch connects the battery (and generator) power to the horn, stoplight switch, charge and neutral lights, and also breaks the ground of the magneto.

Turning the switch to the right connects power to the head light, speedo lights and the tail light. Turning the switch to the left connects power to the taillight only.

Ignition OFF

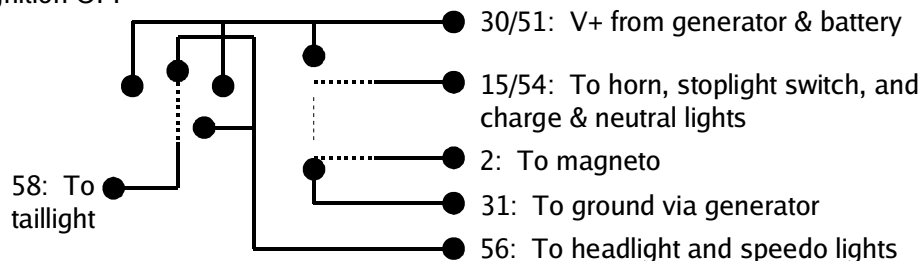

Ignition ON, Lights OFF

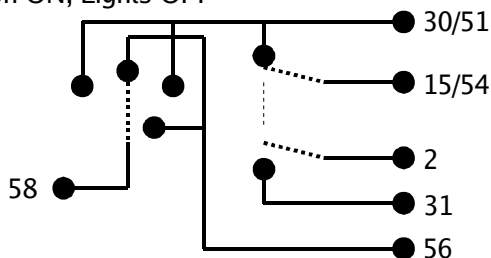

The switch has been pushed in, making contact between 30/51 and 15/54, and breaking contact between 2 and 31.

Ignition ON, Lights ON

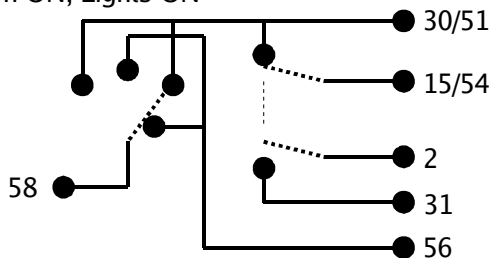

The switch has been turned to the right, making contact between 30/51 and 56 and 58.

BMW Wiring Scheme #1

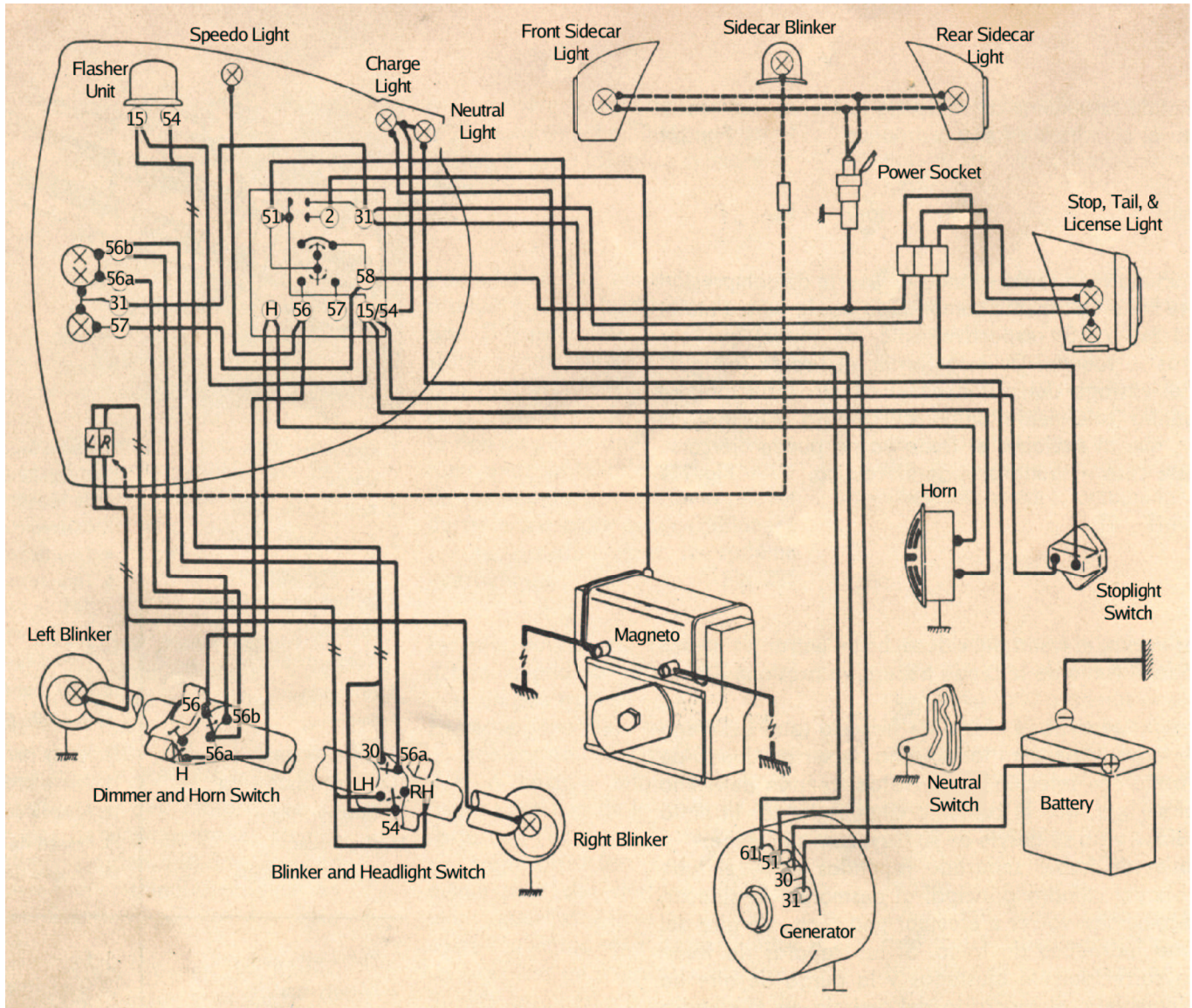

BMW Wiring Scheme #2

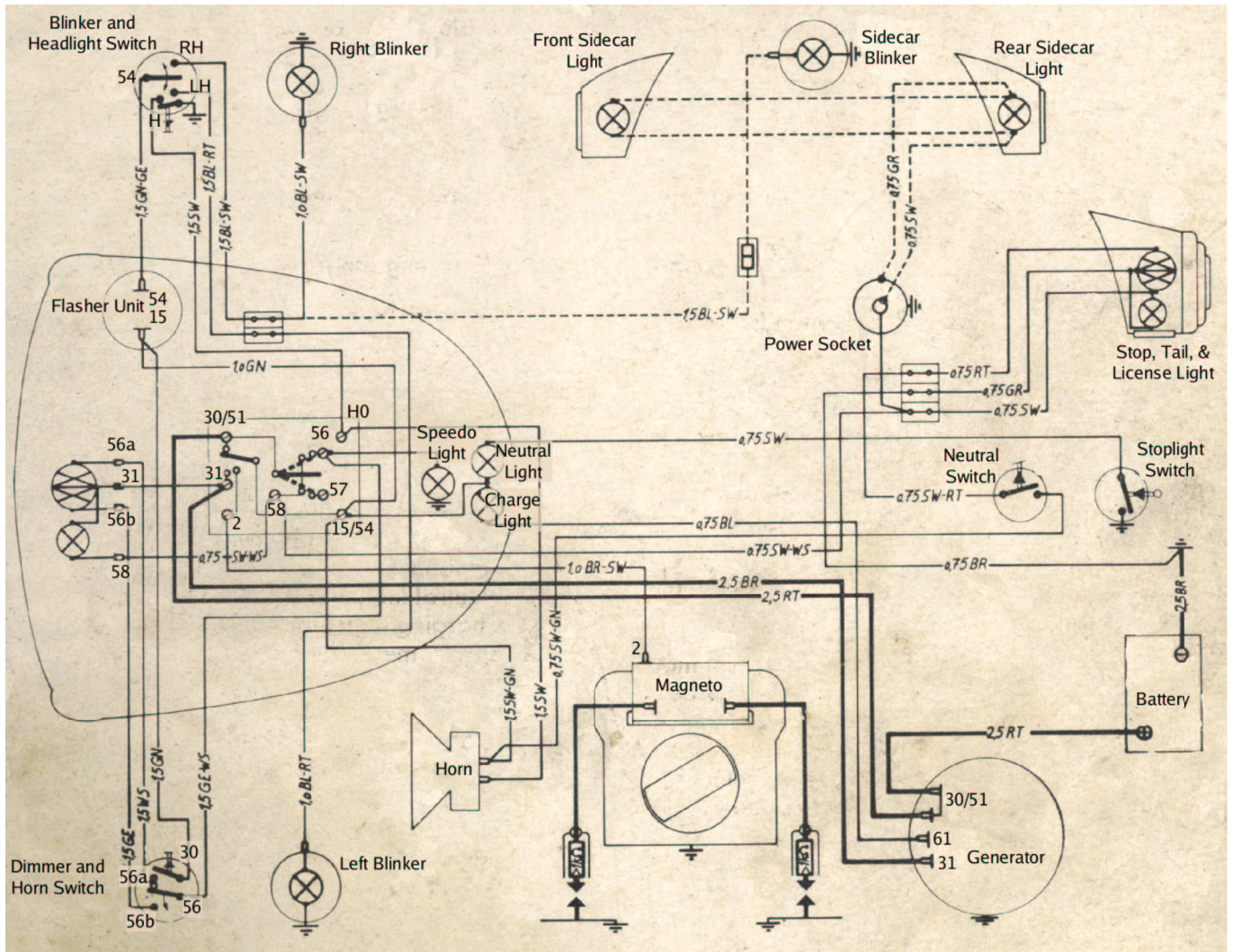

Wire Label (German abbreviation)	Colour
BL	Blue
BR	Brown
GE	Yellow
GN	Green
GR	Grey
RT	Red
SW	Black
VI	Violet
WS	White

Ulrich Seiwert/UIi's Motorradladen Replacement Loom

